



Buy it for looks. Buy it for life.®

Care Instructions

To preserve the finish on the metallic parts of your Moen faucet, apply non-abrasive wax, such as car wax. Any cleaners should be rinsed off immediately.

6. Post Installation - Troubleshooting Guide

Problem	Possible Cause	To Diagnose	Remedy
Hot/cold reversed	Lines reversed/ cartridge installed upside down	Hot/cold reversed	Rotate cartridge stem 180° so that the notch is facing down towards the drain.
No water/low flow	One or both supplies not on to the unit	No water/low flow	Turn both water supply valves counterclockwise to the on position
Leak or drip from spout	Grommets not sealing properly	Leak/drip from spout	Replace cartridge
Only hot/no cold – Only cold/no hot	Balancing spool stuck	Only hot/no cold – Only cold/no hot	Replace cartridge
Stacking (Water comes out of the showerhead during tub fill mode)	Choice of pipe/distance between valve and showerhead less than 46"/multiple elbows/anything restricting flow of water exiting valve	Water comes out of spout and showerhead at the same time	Change pipe to IPS or copper/distance from showerhead and valve moved to at least 46"/ change or remove anything restrictive
	Flow restriction between valve and tub spout	Water comes out of spout and showerhead at the same time causing restriction	Remove tub spout and flush out debris – Replace undersized line or fittings
	Valve installed upside down	Remove cartridge and verify that the outlet hole is in proper location (should be down). "Up" is on the top of the valve	Remove valve and reinstall in the proper orientation
Restricted temperature range	Handle (more common in knob models) is installed upside down	In the off position, able to turn the handle both clockwise and counterclockwise	Remove handle, rotate 180°, re-install
	Temperature limit stop out of position	Remove handle and see Step 5.3	Position temperature limit stop to desired temperature position
Not able to install handle/handle rubs up against escutcheon	Valve installed too far back from finished wall	Handle does not install	Contact Moen for assistance.
Handle is hard to turn	Cartridge stem is difficult to rotate	Difficult movement from handle	Replace cartridge or lubricate

For further assistance, contact Moen at:
 USA: 1-800-289-6636 or visit www.moen.com
 Canada: 1-800-465-6130 or visit www.moen.ca



Buy it for looks. Buy it for life.®

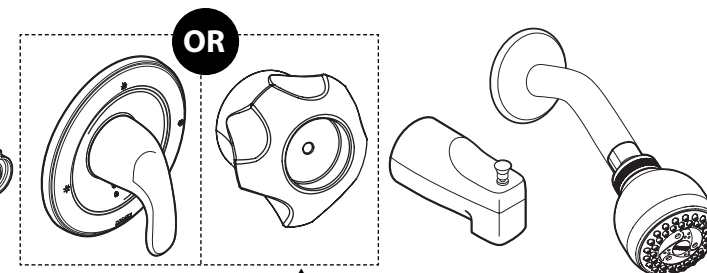

One Handle Tub/Shower Valve Trim

One Handle Shower Only Valve Trim

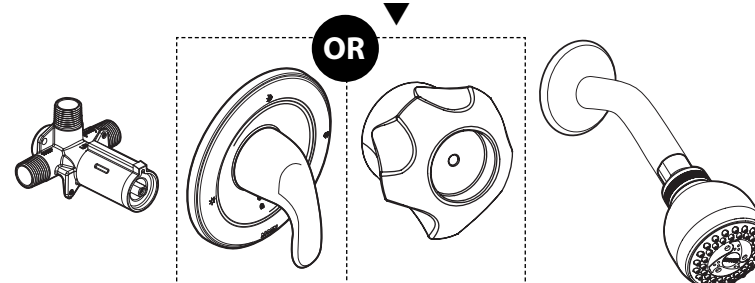

Installation Instructions

Styles and parts vary by model.



INS2151A

For Warranty Support

Model Number _____

Installation Date _____

Thank you for choosing Moen.

Please Contact Moen First

For Installation Help, Missing or Replacement Parts

USA

1-800-BUY-MOEN

1-800-289-6636

Mon. - Fri. 8:00 a.m. to 8:00 p.m. EST

Sat. 9:00 a.m. to 5:30 p.m. EST

www.moen.com

CANADA

1-800-465-6130

Mon. - Fri. 7:30 a.m. to 8:00p.m. EST

www.moen.ca

Table of Contents

Tub/Shower Parts SuppliedE3

Shower Only Parts SuppliedE3

Rough-in Plumbing Variations

 CopperE4

 IPSE4

 PEXE5

 CVPCE5

 Helpful Tools.....E4-E5

Installation SchematicsE6

Thin Wall/Thick Wall and Plaster Ground InstallationE7-E8

Trim Installation.....E8-E9

Setting the Temperature Limit StopE10-E11

Warranty.....E11

Care InstructionsE12

Troubleshooting Guide.....E12

Visit Moen.com for product specific parts diagrams.
Styles and parts vary by model.

Tub/Shower Parts Supplied

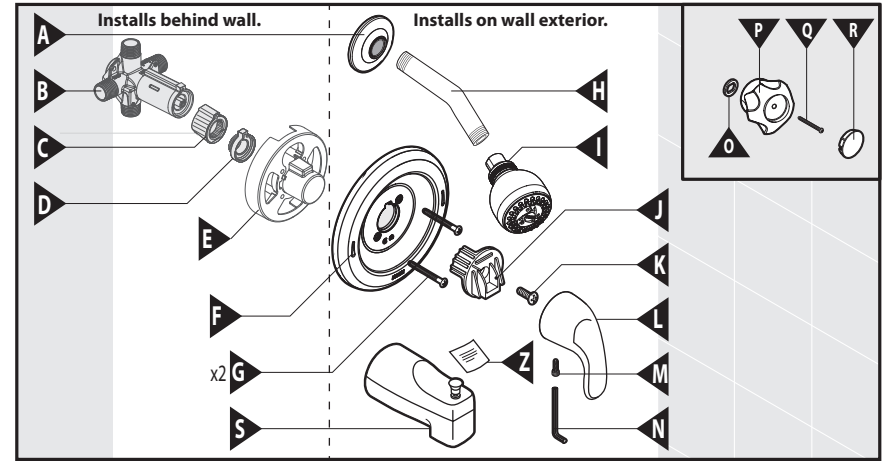

- A. Shower Arm Flange
- B. 4 Port Valve and Stop Tube
- C. Key Stop
- D. Adjustable Temperature Limit Stop
- E. Plaster Ground
- F. Escutcheon
- G. Escutcheon Screws (2-3/16")
- H. Shower Arm
- I. Showerhead
- J. Lever Handle Adapter
- K. Adapter Screw (1/2")
- L. Lever Handle
- M. Hex Screw
- N. 7/64" Hex Wrench
- O. Double D Washer
- P. Knob
- Q. Phillips Screw – Knob (1-1/2")
- R. Knob Cap
- S. Tub Spout
- Z. Product Identification Label

Shower Only Parts Supplied

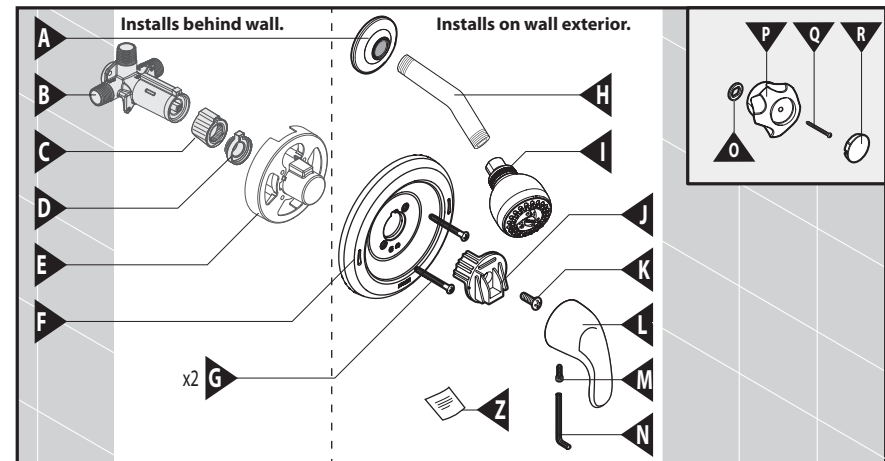

- A. Shower Arm Flange
- B. 3 Port Valve and Stop Tube
- C. Key Stop
- D. Adjustable Temperature Limit Stop
- E. Plaster Ground
- F. Escutcheon
- G. Escutcheon Screws (2-3/16")
- H. Shower Arm
- I. Showerhead
- J. Lever Handle Adapter
- K. Adapter Screw (1/2")
- L. Lever Handle
- M. Hex Screw
- N. 7/64" Hex Wrench
- O. Double D Washer
- P. Knob
- Q. Phillips Screw – Knob (1-1/2")
- R. Knob Cap
- Z. Product Identification Label

1. Determining Your Existing Rough-In Plumbing Installation

If you are replacing your plumbing valve, see below for four common plumbing methods. Specific rough-in fittings are **not supplied**. These may be required for installation. Remove existing handle and valve trim before replacing your valve. **Please follow all local building and plumbing codes.**

Copper

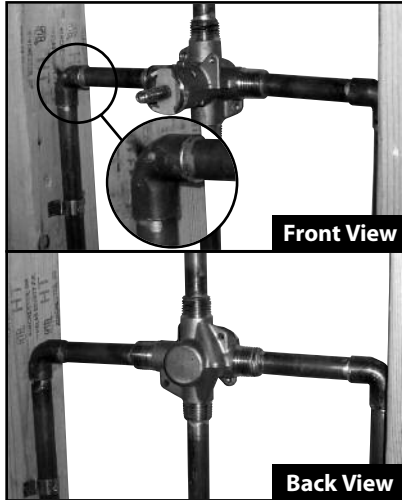

Helpful Tools
For safety and ease of faucet replacement, Moen recommends the use of these helpful tools.

- Safety Glasses
- Measuring Tape
- Torch
- Wire Brush
- Phillips Screwdriver
- Tube Cutter
- Lead-free Solder Kit
- Thermometer
- Thread Seal Tape
- Crescent Wrench
- Pipe Joint Compound
- Flashlight
- Key Hole Saw

PEX

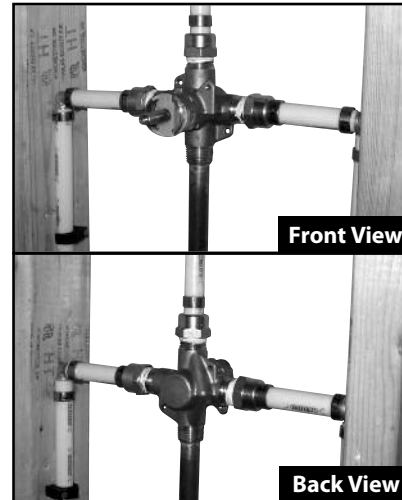

Helpful Tools
For safety and ease of faucet replacement, Moen recommends the use of these helpful tools.

- Safety Glasses
- Measuring Tape
- Pipe Joint Compound
- Crescent Wrench
- Thread Seal Tape
- Phillips Screwdriver
- Full Circle Crimping Tool
- Thermometer
- Tubing Cutter
- Flashlight
- Key Hole Saw

IPS – (Galvanized Iron Pipe/Threaded Connections)

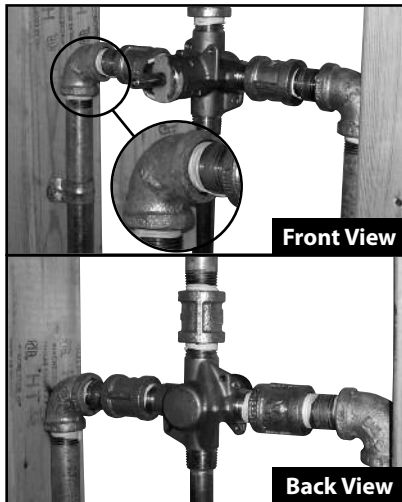

Helpful Tools
For safety and ease of faucet replacement, Moen recommends the use of these helpful tools.

- Safety Glasses
- Measuring Tape
- Thermometer
- Crescent Wrench
- Thread Seal Tape
- Phillips Screwdriver
- Adjustable Wrench
- Pipe Joint Compound
- Flashlight
- Key Hole Saw

CPVC

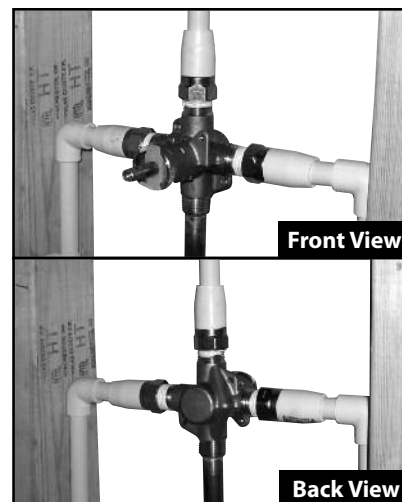

Helpful Tools
For safety and ease of faucet replacement, Moen recommends the use of these helpful tools.

- Safety Glasses
- Measuring Tape
- Pipe Joint Compound
- Crescent Wrench
- Thread Seal Tape
- Phillips Screwdriver
- CPVC Cement
- Thermometer
- CPVC Cleaner
- Tubing Cutter
- Flashlight
- Key Hole Saw

⚠ CAUTION – TURN HOT & COLD WATER SUPPLIES OFF BEFORE REMOVING YOUR CURRENT FAUCET OR DISASSEMBLING YOUR CURRENT VALVE. OPEN FAUCET HANDLE TO RELIEVE WATER PRESSURE AND ENSURE COMPLETE WATER SHUT-OFF HAS BEEN ACCOMPLISHED.

⚠ CAUTION – TURN HOT & COLD WATER SUPPLIES OFF BEFORE REMOVING YOUR CURRENT FAUCET OR DISASSEMBLING YOUR CURRENT VALVE. OPEN FAUCET HANDLE TO RELIEVE WATER PRESSURE AND ENSURE COMPLETE WATER SHUT-OFF HAS BEEN ACCOMPLISHED.

2. Installation Schematics – Measuring for Ideal Tub/Shower Performance

Installation of this product at non-recommended measurements may lead to issues such as water discharge from the showerhead during tub fill mode.

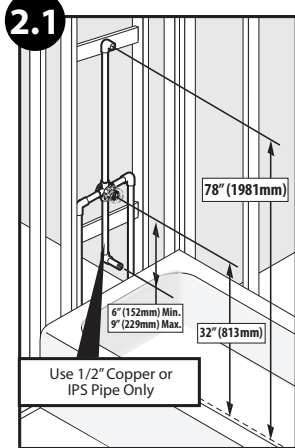

Tub/Shower

Position the valve body 32 inches from the floor of the tub basin. The shower arm should be placed 78 inches above the floor of the tub basin (recommended installation of the shower arm is with a flanged elbow fitting – **not included** – and attached to a wood brace). The tub spout is to be no less than 6 inches and no greater than 11 inches below the valve. If installing a threaded tub spout, connect to the valve with 1/2 inch pipe or 1/2 inch copper tubing with a threaded adapter. If installing a slip-fit tub spout, connect to the valve with only copper tubing – no threaded adapter is needed.

See step 4.3 for tub spout tube length.

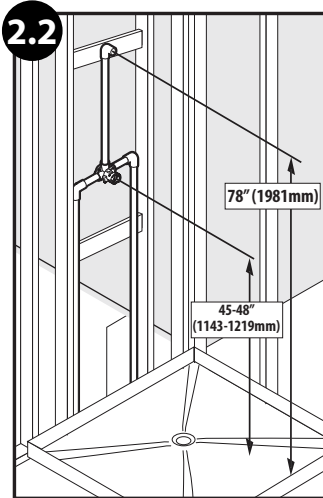

Shower Only

The center of the valve should be 45 inches to 48 inches above the shower stall floor. The shower arm should be placed 78 inches above the floor of the shower stall floor (recommended installation of the shower arm is with a flanged elbow fitting – **not included** – and attached to a wood brace).

3. Installing Your Valve

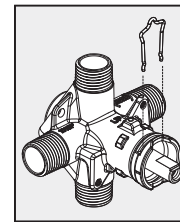
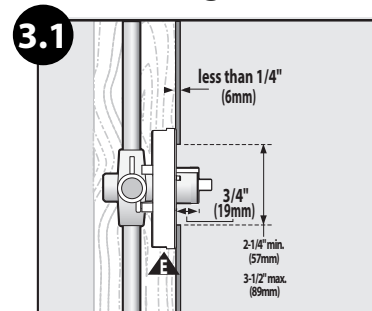

Ensure cartridge retainer clip is installed prior to escutcheon installation.

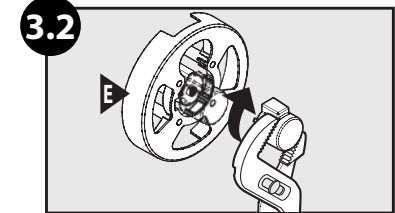

Thin Wall Installation

For Walls Thinner Than 1/4 inch

- 3.1** The “Thin Wall” method is used when the tub/shower wall is less than 1/4 inches thick (such as fiberglass tub surround) and will be the main source of support for the valve. The plaster ground (E) remains attached to the valve. A 2-1/4 inches to 3-1/2 inches diameter hole is cut thru the wall for this method.
- 3.2** Break away the black plastic protective cover using pliers and rotating clockwise.
- 3.3** Remove the escutcheon screws (G), place product identification label (Z) **on back of escutcheon**, make sure wall is clean, place the escutcheon (F) over the stop tube (B), then reinstall the screws (G). A gasket on the back of the escutcheon provides a seal against the finished wall.

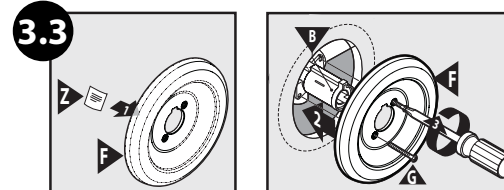

Go To Step 4.1

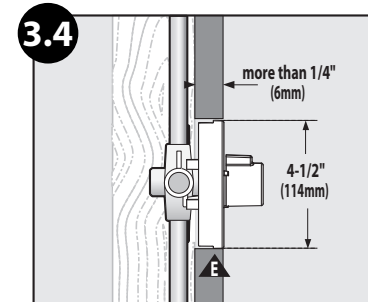

Thick Wall Installation

For Walls Thicker Than 1/4 inch

- 3.4** The “Thick Wall” installation method is used when the tub/shower wall is greater than 1/4 inches thick. “Thick Walls” are usually built up with materials such as cement board, drywall, tile, etc. The valve is secured by straps (**not included**) holding the water inlet lines to the framing members (2X4s) as shown in steps 2.1 and 2.2. The valve also features mounting holes to screw the valve to a cross member attached behind the valve if desired.

Attach the plaster ground (E) to the valve body using the 2-3/16 inches escutcheon screws (G). Keep the plaster ground (E) attached to the valve until the valve has been positioned and secured. The plaster ground (E) is positioned so that it is flush with the finished wall. This ensures that the valve will be at the correct position to accept the trim.

The hole in the wall should be the same size (4-1/2 inches) as the plaster ground (E). This hole will allow access for future servicing if necessary.

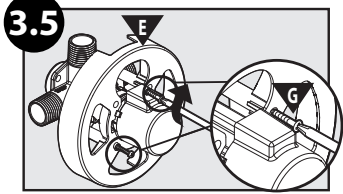

3.5 Once the valve is secured in place, remove the escutcheon screws (G) and the plaster ground (E). **Keep the escutcheon screws (G) for installation of the escutcheon (F) and discard the plaster ground (E).**

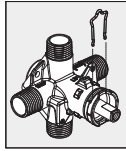

Ensure cartridge retainer clip is installed prior to escutcheon installation.

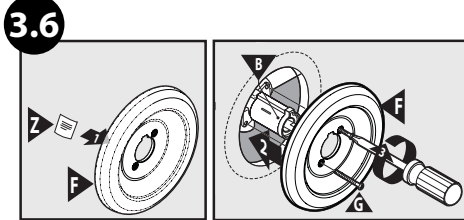

3.6 Place product identification label (Z) **on back of escutcheon**, make sure wall is clean, place the escutcheon (F) over the stop tube (B) then re-install the screws (G). A gasket on the back of the escutcheon provides a seal against the wall.

Go To Step 4.1

4. Installing Your Moen Tub/Shower Trim

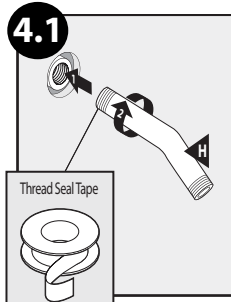

Wrap thread seal tape around the threads of the shower arm (H) then screw the arm into the threaded connection in the wall.

If there is a rubber washer inside the threaded adapter on the showerhead, continue to step 4.2A. If there is no rubber washer, then proceed to step 4.2B.

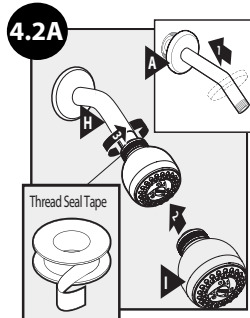

4.2A Plastic Shower Ball
Seal around the shower arm hole with sealant (caulk) then slide shower flange (A) over shower arm (H). Remove any debris from the shower arm to ensure proper flow. Then, simply thread showerhead (I) onto shower arm (H).

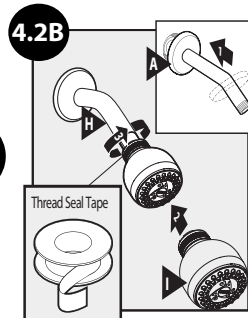

4.2B Metal Shower Ball
Seal around the shower arm hole with sealant (caulk) then slide shower flange (A) over shower arm (H). Wrap thread seal tape around threads at bottom of shower arm (H). Remove any debris from the shower arm to ensure proper flow. Thread showerhead (I) onto shower arm (H).

OR

Threaded Tub Spout Installation

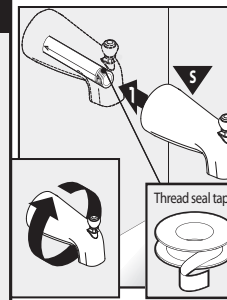
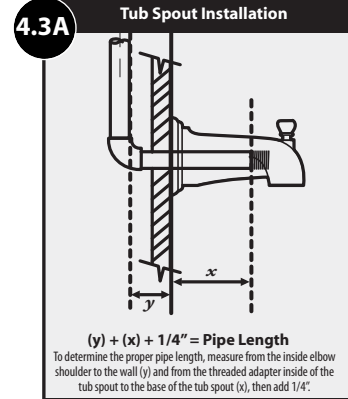

If this is a shower only installation, skip to step 4.4.

IPS (threaded) spouts are designed to screw onto a pipe with 1/2 inch male pipe threads. To determine the proper pipe length, measure from the inside elbow shoulder to the wall (y) and from the threaded adapter inside of the tub spout to the base of the tub spout (x), then add 1/4". Place thread seal tape around the pipe threading and a sealant (plumbers putty or caulk) around the base of the pipe to prevent leaking behind the wall.

Slip Fit Tub Spout Installation

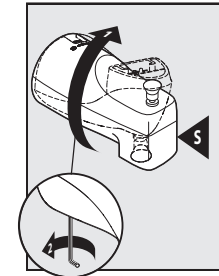
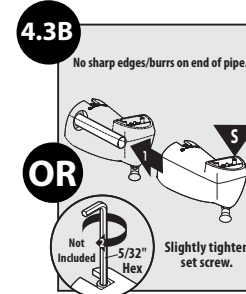

Some models may feature a slip fit installation with no threaded adapter in the tub spout. For these installations, slip the tub spout onto pipe pointing up and slightly tighten the set screw. Rotate tub spout to final position and fully tighten set screw in place.

Cartridge Orientation

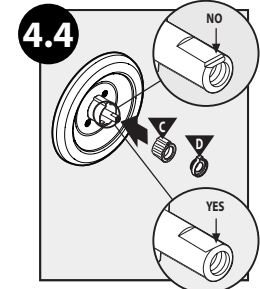

Now you are ready to attach the handle. Rotate so the notch at the end of the stem is facing down towards the drain. Insert the key stop (C) and the adjustable limit stop (D) into stop tube as shown.

For Lever Handles Installed with Plastic Handle Adapter (J)

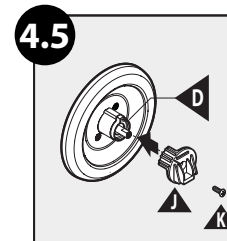

If this is a lever handle that attaches with the lever handle adapter (J), attach the plastic handle adapter (J) to the cartridge stem using the 1/2 inch adapter screw (K). Make sure the ridges on the back of the adapter (J) are to the left of the tab on limit stop (D).

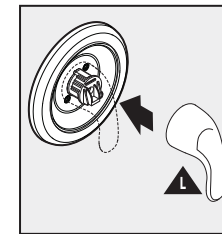

Place the lever (L) on the lever handle adapter.

Other Possible Handle Type Installations

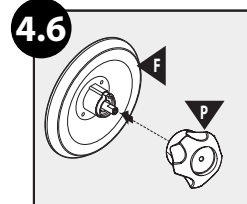

Place the knob handle (P) – onto the cartridge – make sure the indicator on the knob is pointing down.

5. Setting The Temperature Limit Stop and Finishing Your Tub/Shower Installation

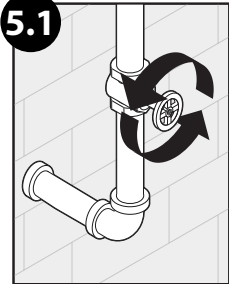

Turn on the hot and cold water supply to check for leaks and set temperature limit stop.

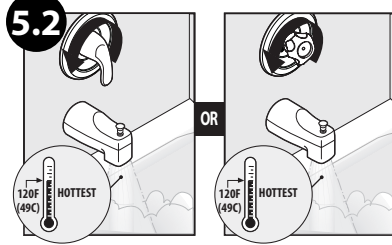

Rotate the lever **OR** knob counterclockwise until the water is to the maximum desired temperature, not to exceed 120 degrees F (49 degrees C). Seasonal maintenance of the maximum outlet temperature may be required due to changes in groundwater temperature. **TURN LEVER OR KNOB TO THE OFF POSITION ONCE THE TEMPERATURE IS SET.**

**If temperature exceeds 120 degrees, go to step 5.3.
If temperature is less than 120 degrees, go to step 5.4.**

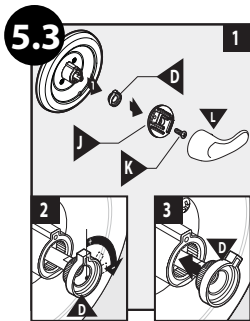

Remove the lever (L) and lever handle adapter (J). Note the position of the stop. Position the adjustable temperature limit stop (D) so the lever or knob stops at that position. This prevents the lever or knob from being turned into an unsafe temperature.

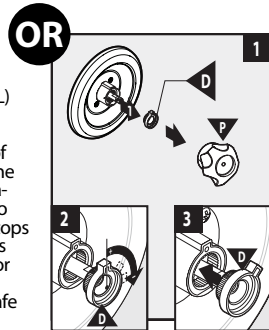

Remove the knob handle (P). Note the position of the stop. Position the adjustable temperature limit stop (D) so the lever or knob stops at that position. This prevents the lever or knob from being turned into an unsafe temperature.

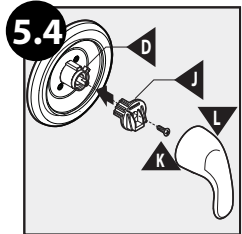

After setting the adjustable temperature limit stop to the desired position, remove the lever (L), reattach the lever handle adapter (J), adapter screw (K), and lever (L) – make sure ridges on back of (J) are to the left of the tab on (D).

OR

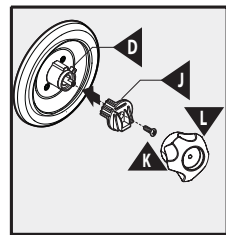

After setting the adjustable temperature limit stop to the desired position, reattach the double D washer (O) and knob (P) – make sure indicator on the knob is pointing down.

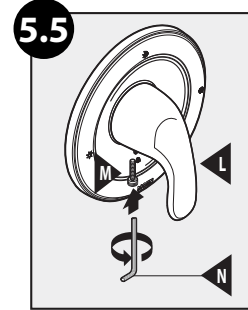

Using 7/64 inches hex wrench (N), insert and tighten hex screw (M) into lever (L).

OR

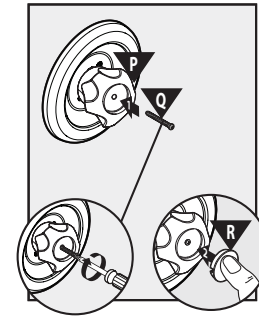

OR insert 1-1/2 inch Phillips screw (Q). Tighten screw and insert cap (R).

Moen Lifetime Limited Warranty

Moen products have been manufactured under the highest standards of quality and workmanship. Moen warrants to the original consumer purchaser for as long as the original consumer purchaser owns their home (the "Warranty Period" for homeowners), that this faucet will be leak- and drip-free during normal use and all parts and finishes of this faucet will be free from defects in material and manufacturing workmanship. All other purchasers (including purchasers for industrial, commercial and business use) are warranted for a period of 5 years from the original date of purchase (the "Warranty Period" for non-homeowners).

If this faucet should ever develop a leak or drip during the Warranty Period, Moen will FREE OF CHARGE provide the parts necessary to put the faucet back in good working condition and will replace FREE OF CHARGE any part or finish that proves defective in material and manufacturing workmanship, under normal installation, use and service. Replacement parts may be obtained by calling 1-800-289-6636 (Canada 1-800-465-6130), or by writing to the address shown. Proof of purchase (original sales receipt) from the original consumer purchaser must accompany all warranty claims. Defects or damage caused by the use of other than genuine Moen parts is not covered by this warranty. This warranty is applicable only to faucets purchased after December, 1995 and shall be effective from the date of purchase as shown on purchaser's receipt.

This warranty is extensive in that it covers replacement of all defective parts and finishes. However, damage due to installation error, product abuse, product misuse, or use of cleaners containing abrasives, alcohol or other organic solvents, whether performed by a contractor, service company, or yourself, are excluded from this warranty. Moen will not be responsible for labor charges and/or damage incurred in installation, repair or replacement, nor for any indirect, incidental or consequential damages, losses, injury or costs of any nature relating to this faucet. Except as provided by law, this warranty is in lieu of and excludes all other warranties, conditions and guarantees, whether expressed or implied, statutory or otherwise, including without restriction those of merchantability or of fitness for use.

Some states, provinces and nations do not allow the exclusion or limitation of incidental or consequential damages, so the above limitations or exclusions may not apply to you. This warranty gives you specific legal rights and you may also have other rights which vary from state to state, province to province, nation to nation. Moen will advise you of the procedure to follow in making warranty claims. Simply write to Moen Incorporated using the address below. Explain the defect and include proof of purchase and your name, address, area code and telephone number.

Moen Incorporated
25300 Al Moen Drive, North Olmsted, Ohio 44070-8022 U.S.A.