



ENGLISH

kēvo™

Installation and User Guide

**Required Tools**

Ruler Phillips Head Screwdriver

**Additional Accessories (depending on application)**

Hammer Wood block

You can view the Kevo installation video online by scanning the code to the right or by visiting [www.kwikset.com/kevo/support](http://www.kwikset.com/kevo/support)

**Parts in the Box**

<p><b>Latch and Strike</b></p>	<p><b>Exterior Assembly</b></p>	<p><b>Interior Assembly</b></p>
	<p><b>Kevo Fob</b></p>	

**1 Prepare door and check dimensions**

If drilling a new door, use the supplied template and the complete door drilling instructions available at [www.kwikset.com/doorprep](http://www.kwikset.com/doorprep).

<p><b>A</b> Measure to confirm that the hole in the door is either 2-1/8" (54 mm) or 1-1/2" (38 mm).</p>	<p><b>B</b> Measure to confirm that the backset is either 2-3/8" or 2-3/4" (60 or 70 mm).</p>	<p><b>C</b> Measure to confirm that the hole in the door edge is 1" (25 mm).</p>	<p><b>D</b> Measure to confirm that the door is either 1-3/8" or 1-3/4" (35 mm or 44 mm) thick.</p>
--	---	--	---

Note: Additional door preparation may be required for doors with 1-1/2" (38 mm) holes. Consult the deadbolt drilling instructions at [www.kwikset.com/doorprep](http://www.kwikset.com/doorprep).

**2 Install latch and strike**

<p><b>A</b> Is the door edge chiseled?</p> <div style="display: flex; justify-content: space-around;"> <div style="text-align: center;"> <p><b>YES</b></p> <p>Use latch "A". Extend the latch bolt as shown.</p> </div> <div style="text-align: center;"> <p><b>NO</b></p> <p>Use latch "A2". Extend the latch bolt as shown.</p> </div> </div>	<p><b>B</b> Hold the latch in front of the door hole, with the latch face flush against the door edge.</p>	<p><b>D</b> Which latch are you installing?</p> <div style="display: flex; justify-content: space-around;"> <div style="text-align: center;"> <p><b>Latch "A"</b></p> </div> <div style="text-align: center;"> <p><b>Latch "A2"</b></p> </div> </div>
<p><b>C</b> Are the latch holes centered in the door hole?</p> <div style="display: flex; justify-content: space-around;"> <div style="text-align: center;"> <p><b>YES</b></p> <p>No adjustment is required. Proceed to next step.</p> </div> <div style="text-align: center;"> <p><b>NO</b></p> <p>Rotate latch face as shown to extend latch.</p> </div> </div>		
<p><b>E</b> Install strike on the door frame.</p>		

### 3 Install exterior assembly

**A** What is the diameter of the hole in the door?

Diameter is 2-1/8" (54 mm).

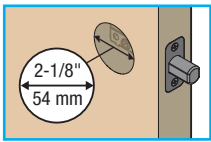

"F" is required for installation. Install "F" on "E".

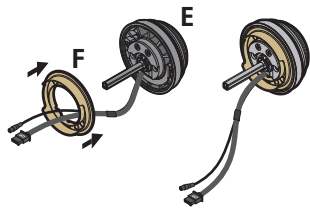

or

Diameter is 1-1/2" (38 mm).

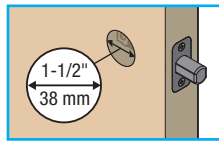

"F" is not needed for installation. Discard "F".



**B** What is the thickness of your door?

Door is 1-3/8" (35 mm) thick.

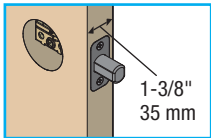

Use the shorter, silver screws.



or

Door is 1-3/4" (44 mm) thick.

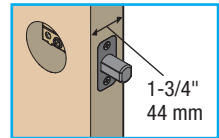

Use the longer, gold screws.



**C** Install exterior assembly and mounting plate.

**a** Locate mounting plate (K). Note: it may be on the back of the interior assembly (L).

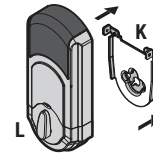

**b** Cables go underneath latch.

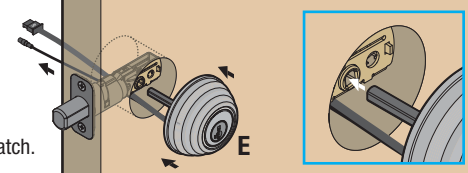

**c** Route cables through center hole, then push cables into side hole.

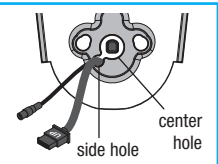

**d** Tighten screws evenly (Q/R (2x)). Keep parallel to edge of door.

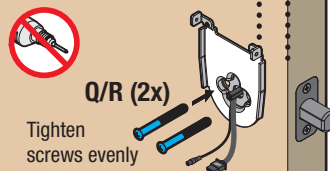

**e** Insert key and test latch. If latch does not extend or retract smoothly, adjust screws (Q/R). Remove key when finished and make sure the latch bolt is fully extended.

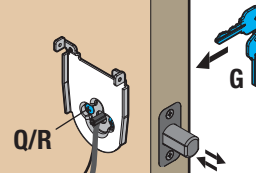

### 4 Install interior assembly

**A** Remove battery cover and battery pack from interior assembly.

**a** Make sure turnpiece is in the vertical position.

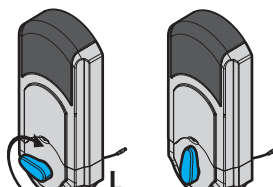

**b** Remove interior cover.

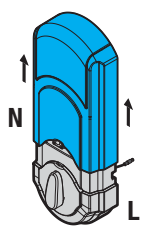

**c** Remove battery pack.

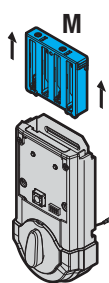

Do not install batteries yet.

**B** Connect the thinner cable.

**CAUTION:** Handle cables with care to avoid cable damage. Do not pull or use force.

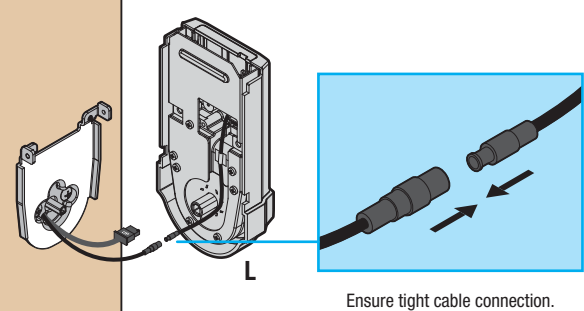

Ensure tight cable connection.

**C** Connect the thicker cable.

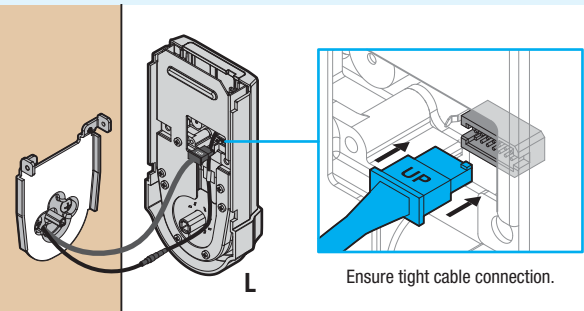

Ensure tight cable connection.

**D** Properly route cables and install interior assembly.

**a** Route the thinner cable around the outside of the thicker cable's square connector.

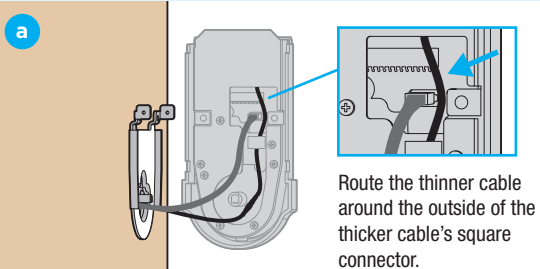

**b** Tuck the thinner cable's connector behind the backplate (as indicated by the sticker on the interior assembly).

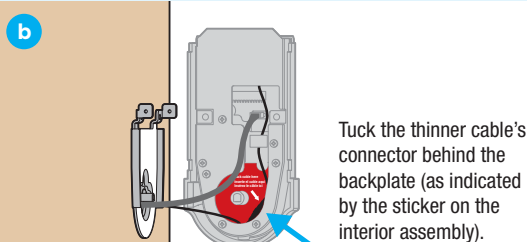

**c** Lay thicker cable flat against the interior housing.

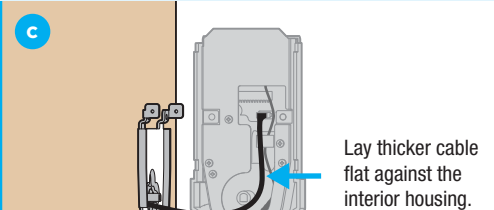

**d** Push the turnpiece shaft onto the torque blade. Avoid pinching the excess thinner cable by pulling it away from the torque blade.

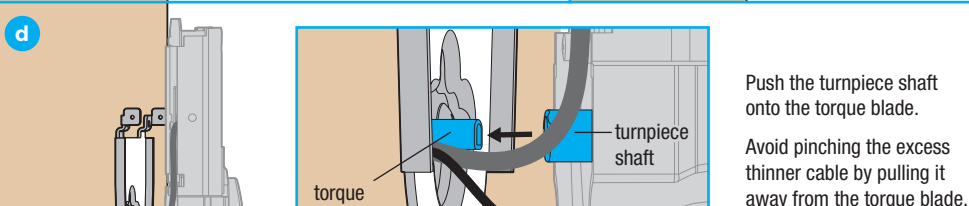

**e** Note: Turnpiece may not rotate smoothly until after step 5.

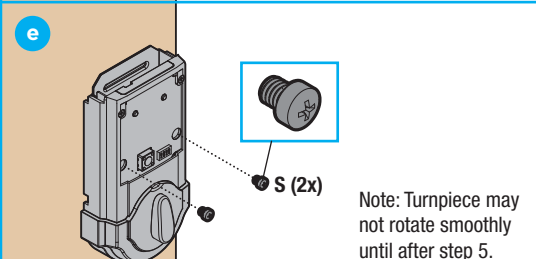

## 5 Perform door handing process

This step will teach the lock the orientation of your door and is crucial for lock operation.

**A** Install 4 AA batteries in the battery pack.

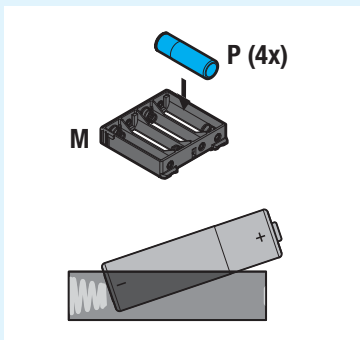

⚠ Ensure correct polarity. For best results, use new, non-rechargeable Alkaline batteries only.

**B** Make sure the door is open. Insert the battery pack while pressing and holding the Program button. Release the button when the battery pack is all the way inside the lock interior.

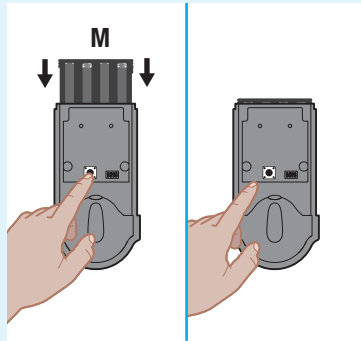

**C** The Status LED will flash red and green, and the lock will beep. Press and release the Program button again. The latch bolt will retract and extend on its own.

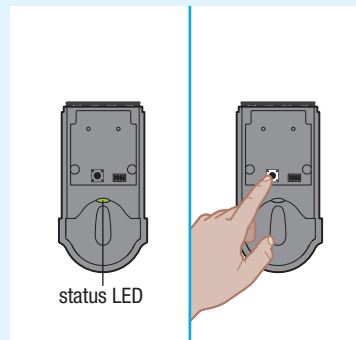

**D** Did the latch bolt retract and extend on its own?

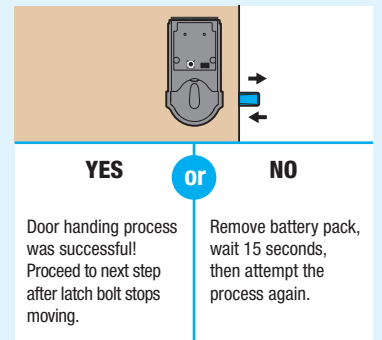

## 6 Wake up and test Kevo fob

**A** Press and release the enroll button on the fob with a ballpoint pen to wake it up. When the fob's LED flashes green, the fob is awake and ready for use.

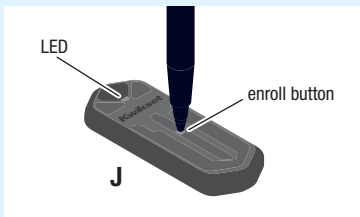

**B** Bring your fob and standard key outside with you and close the door. Make sure there is a clear line of sight between the lock and the fob. Touch the deadbolt rose.

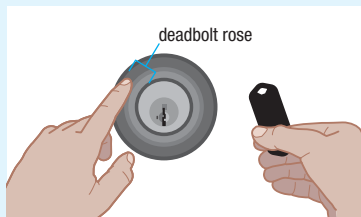

Note: The deadbolt rose is the metallic surface behind the light ring.

**C** The light ring will spin blue, then flash amber once and you will hear one beep. The door will lock.

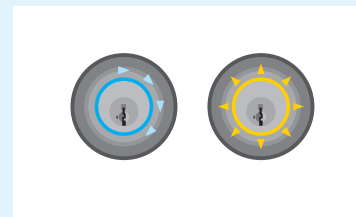

**D** Touch the deadbolt rose again. The light ring will spin blue, then flash green twice and you will hear two beeps. The door will unlock.

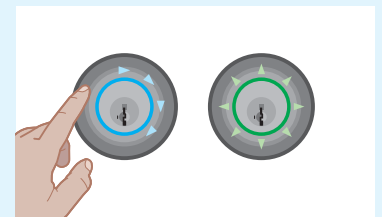

If your fob is unable to communicate with the lock, see the online Troubleshooting Guide at [www.kwikset.com/kevo/support](http://www.kwikset.com/kevo/support).

## 7 Download the app and set up your smartphone

**A** Download the Kevo app at [www.kwikset.com/kevo/app](http://www.kwikset.com/kevo/app) or scan the QR code below.

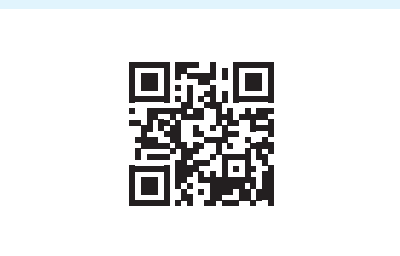

**B** Follow the instructions inside the app to create an account, enroll your first smartphone and send eKeys to family and friends.

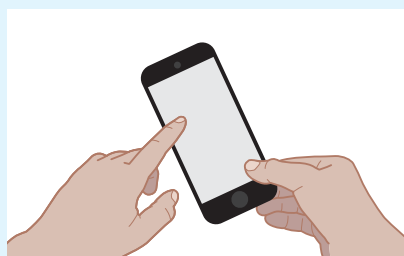

**C** When using your phone to lock and unlock the door, make sure the phone is on, Bluetooth is enabled, and the Kevo app is running in the background.

You may hold the phone in your hand, pocket, bag or purse as long as there is a clear line of sight between the lock and the phone.

Press the deadbolt rose to lock and unlock the door.

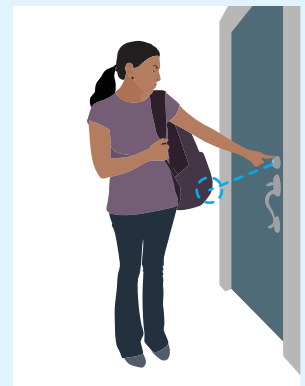

## 8 Re-key the lock (if needed) and install the battery cover

**A** Re-key the lock (if needed).

**a** **IMPORTANT:** Remove battery pack before re-keying.

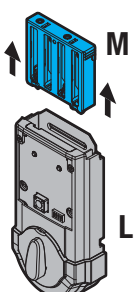

**b** Re-key the lock to work with your existing key. See the supplied SmartKey Re-key instructions for more information.

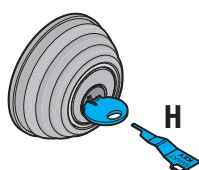

**c** Reinstall battery pack.

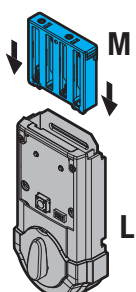

**D** Install battery cover.

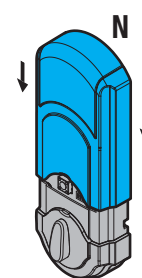

## Kevo Reference Guide

### Kevo at a Glance

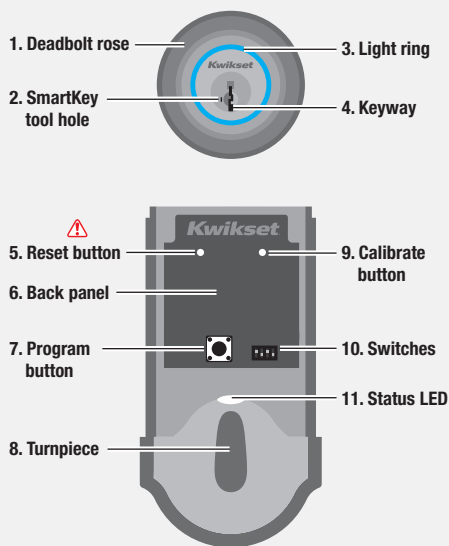

1. Touch Kevo anywhere on the metallic surface behind the light ring to lock and unlock.
2. Insert your SmartKey tool here when rekeying your lock to work with your existing key.
3. Changes color to communicate with you.
4. Insert your standard key here.
5. **⚠** Only use to reset Kevo to delete all eKeys and fobs. See "System Reset" for more information.
6. Where all the programming features are located.
7. Use to enroll phones and fobs.
8. Use to manually lock and unlock Kevo from the inside. When the turnpiece is vertical, Kevo is locked. When it is horizontal, Kevo is unlocked.
9. Use to manually calibrate phones and fobs.
10. Use to enable and disable the Status LED, Triple Touch Lock and Audio.
11. Communicates whether the door is locked or unlocked and flashes red for a low battery alert. Can be turned on and off by Switch #1.

### Kevo-Compatible Devices

#### Smartphones and Smart Devices

A Kevo-compatible smartphone (or other mobile internet-connected device or tablet) must have Bluetooth Smart Ready/ Bluetooth 4.0 and an app specific to the device must be installed. Find out if your device is compatible at [www.kwikset.com/kevo/devices](http://www.kwikset.com/kevo/devices).



#### Kevo Fob

A Kevo Fob is a Bluetooth device that provides the same touch-to-open convenience as a smartphone.

Additional fobs can be purchased as needed. Up to eight fobs can be enrolled in a single Kevo lock. A single fob can be enrolled in up to 25 different Kevo locks.

**Note:** You may choose to use only Kevo fobs, only smartphones or a mix of both in your Kevo system.

#### Standard Key

Always make sure you have access to your standard key.

### Switches

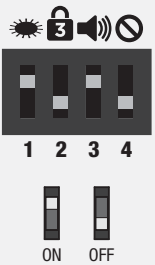

#### Switch 1 Status LED

Door lock status LED blinks every 6 seconds. ON position is factory default.

#### Switch 2

##### ⚠ Triple Touch Lock

See "Triple Touch Lock." OFF position is factory default.

#### Switch 3

##### Audio

Beeping sound is heard during programming and normal operation. ON position is factory default.

#### Switch 4

##### Future Feature

### Triple Touch Lock

This is a convenient feature that allows you to lock the door from the outside without the use of a smartphone or fob.

You might use Triple Touch Lock if you are using only a standard key in your system but wish to lock the door by touch, if your smartphone or fob is disabled, or if you have a visitor in your home that will leave and lock the door behind them.

**Note:** This feature is OFF by default. To enable it, flip Switch #2 to the ON position, then lock or unlock the door by touching the deadbolt rose.

To lock the door with this feature, touch the deadbolt rose three times, pausing briefly between each touch. The light ring will spin blue, flash amber, and you will hear one beep (if switch #3 is on).

**⚠ CAUTION:** With this feature enabled, it is possible to lock yourself outside if you don't have an enrolled smartphone, Kevo fob or standard key with you.

### Advanced Features

#### Inside-Outside Sensor

The Kevo lock features a sensor that can tell if your device is inside or outside your home to help prevent your door from being unlocked by unauthorized users while your device is inside.

Each device in your Kevo system will automatically calibrate to enable this sensor as of software version 1.2.3. For more information on calibration, go to [www.kwikset.com/kevo/support](http://www.kwikset.com/kevo/support).

#### History Log

A history of the lock's activity may be viewed through the Kevo app or by logging into the web portal: [www.mykevo.com](http://www.mykevo.com).

#### Notifications

The Kevo app can send notifications when the door is locked and unlocked by eKey holders. You can choose to receive the system's default notifications or set up custom notifications to monitor a specific user or time frame.

#### Kevo App Passcode

Kevo features an optional, added-security passcode that you can enable inside the app to be used in addition to the app's password. Enabling the passcode will require you to enter a 4-digit PIN whenever you access the app, and it protects your Kevo account against unauthorized changes when your phone is unlocked.

### Error Notifications

A complete audio/visual chart of all the lights and sounds in the Kevo system is available in the online Troubleshooting Guide at [www.kwikset.com/kevo/support](http://www.kwikset.com/kevo/support).

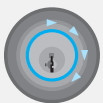

**Blue Spinning and Shutting Off:** Kevo was unable to establish a connection with your device, or Kevo detected the device on the inside of the door. If this happens frequently, see the online Troubleshooting Guide.



**Top Two LEDs are Solid Red:** The AA batteries in the Kevo interior are low and need to be replaced.



**Magenta Flash:** Your device is outside of activation range. Touch the deadbolt rose again. As of software version 1.2.3, your device will automatically calibrate so that Kevo's inside-outside sensor adjusts to your device's new location. You may need to touch the lock a few times for it to learn your device's new location.



**Bottom LED is Solid Red:** The fob battery is low and needs to be replaced. See the online Troubleshooting Guide for instructions.



**Red Flash:** The lock has detected an unauthorized device within activation range. Kevo will not unlock. If this happens frequently, see the online Troubleshooting Guide.



**Side LEDs Flashing Red:** The deadbolt has jammed. Check your door for alignment and make sure the latch bolt can operate smoothly.

### System Reset

**⚠ WARNING:** Resetting your Kevo system will restore your lock to factory default settings and delete all smartphones and fobs from Kevo's memory.

If you wish to perform a system reset, **press and hold** the Reset button on the back panel for 10 seconds until the lock beeps and the light ring flashes red.



**Phones:** After a system reset, you will need to re-enroll and your Owner phone. You will still be able to send eKeys at no charge to anyone who previously had an active eKey at the time of reset.

**Fobs:** After a system reset, all fobs will need to be re-enrolled. See the online Troubleshooting guide for instructions.

### Important Safeguards

1. Read all instructions in their entirety.
2. Familiarize yourself with all warning and caution statements.
3. Remind all family members of safety precautions.
4. Always have access to your lock's standard key.
5. If using the Triple Touch Lock feature, make sure to have your smartphone, fob or standard key with you to prevent locking yourself out.
6. Familiarize yourself with all light ring error notifications.
7. Replace low batteries immediately.
3. Protect the password to your Kevo app and web portal accounts.
4. When sending an eKey, always double-check that you are sending it to the correct recipient.
5. Protect and restrict access to your smartphone so that your app settings cannot be altered without your knowledge.
6. Enable the Kevo app's security passcode so that your app settings cannot be altered without your knowledge.
7. When sending eKeys, be aware of the difference between an Admin user and other users in the system: an Admin user can send, disable and delete eKeys.
8. If your smartphone is lost or stolen, use the Kevo web portal ([www.mykevo.com](http://www.mykevo.com)) to disable it.
9. If a fob in your Kevo system is lost or stolen, reset your lock to delete it from memory.

#### Preventing Inadvertent Unlocking of Your Door

**⚠ WARNING:** Failure to follow these safeguards could result in your lock opening inadvertently.

1. Avoid keeping and storing phones and fobs unnecessarily close to the lock when inside the home.
2. Restrict access to your Kevo lock's back panel and routinely check your settings to ensure they have not been altered without your knowledge.

**⚠ CAUTION:** Prevent unauthorized entry. Because anyone with access to the back panel can change your Kevo lock's settings, you must restrict access to the back panel and routinely check your settings to ensure they have not been altered without your knowledge.

**⚠ CAUTION:** As with any radio-based technology, it should be noted that the accuracy and reliability of the Kevo lock's inside-outside sensor cannot be guaranteed. Users should not rely solely on the Kevo lock's sensor for security purposes and should always use caution. Kwikset assumes no responsibility for incorrect results or damages resulting from the use of the Kevo lock's sensor.

Certain home configurations may impede the Kevo lock's sensor more than others. Example: *Your home office is located next to your entryway, and part of the office extends past the front door, jutting into the front yard. If your device is being actively used in that office extension, the Kevo lock's sensor could possibly detect the device as being outside of your home while that device is in active use.*

**⚠ WARNING:** This Manufacturer advises that no lock can provide complete security by itself. This lock may be defeated by forcible or technical means, or evaded by entry elsewhere on the property. No lock can substitute for caution, awareness of your environment, and common sense. Builder's hardware is available in multiple performance grades to suit the application. In order to enhance security and reduce risk, you should consult a qualified locksmith or other security professional.

### Need Help?

If you have questions, our highly trained Kevo Support team can provide you with the assistance you need:



1-800-327-5625



1-800-327-5625



1800 623 118



0800 736 776

[www.kwikset.com/kevo/support](http://www.kwikset.com/kevo/support)