

Kozy-World®

VENT-FREE GAS DUAL FUEL FIREPLACE

MODEL #GFD 2042 / 2670 /

3280R / 3290R



0418GF006S

ANSI Z21.11.2-2013

⚠ WARNING: This appliance is equipped for (Natural and Propane) gas. Field conversion is not permitted other than between natural or propane gases.

⚠ CAUTION - FOR YOUR SAFETY

⚠ WARNING: IF THE INFORMATION IN THIS MANUAL IS NOT FOLLOWED EXACTLY, A FIRE OR EXPLOSION MAY RESULT CAUSING PROPERTY DAMAGE, PERSONAL INJURY OR LOSS OF LIFE.

- Do not store or use gasoline or other flammable vapors and liquids in vicinity of this or any other appliance.

WHAT TO DO IF YOU SMELL GAS

- Do not try to light any appliance.
 - Do not touch any electrical switch; do not use any phone in your building.
 - Immediately call your gas supplier from a neighbor's phone. Follow the gas supplier's instructions.
 - If you cannot reach your gas supplier, call the fire department.
- Installation and service must be performed by a qualified installer, service agency or the gas supplier.

This is an unvented gas-fired heater. It uses air (oxygen) from the room in which it is installed. Provisions for adequate combustion and ventilation air must be provided. Refer to Air For Combustion and Ventilation section on page 9-11 of this manual.

**INSTALLER: Leave this manual with the appliance.
CONSUMER: Retain this manual for future reference.**

This appliance may be installed in an aftermarket, permanently located manufactured (mobile) home, where not prohibited by local codes. This appliance is only for use with propane or natural gas. This appliance is equipped with a simple means to switch between propane and natural gas. Field conversion by any other means including the use of a kit is not permitted.



Questions, problems, missing parts? Before returning to your retailer, call our Technical Service Department at 1-814-643-1775.

IMDFVFFW - 2015-04-27

TABLE OF CONTENTS

Specifications	2
Important Safety Information	3
Product Identification	5
Product Features	6
Unpacking	6
Hood Assembly	7
Preparing for Installation	8
Installation	11
Operation	23
Remote Control Operation	25
Care and Maintenance	32
Troubleshooting	35
Replacement Parts	37
Accessories	39
Warranty	40

⚠ WARNING: Read the Installation & Operating Instructions before using this appliance.
IMPORTANT: Read all instructions and warnings carefully before starting installation.
Failure to follow these instructions may result in possible injury to persons or a fire hazard and will void the warranty.

Model	GFD2042 Series		GFD2670 Series		GFD 3280R / 3290R Series	
Input Rating	20,000 BTU/Hr		27,500 BTU/Hr		32,000 BTU/Hr	
Gas Type	LP	NG	LP	NG	LP	NG
Manifold Pressure	10" WC	4.5" WC	10" WC	4.5" WC	10" WC	4.5" WC
Max. Inlet Pressure	13" WC	10" WC	13" WC	10" WC	13" WC	10" WC
Min. Inlet Pressure	8" WC	3.5" WC	8" WC	3.5" WC	8" WC	3.5" WC

SERVICE HINTS

When Gas Pressure Is Too Low

- pilot will not stay lit
- burners will have delayed ignition
- fireplace will not produce specified heat
- for propane/LP units, propane/LP gas supply may be low

You may feel your gas pressure is too low. If so, contact your local natural or propane/LP gas supplier.

IMPORTANT SAFETY INFORMATION

IMPORTANT: Read this owner's manual carefully and completely before trying to assemble, operate, or service this heater. Improper use of this heater can cause serious injury or death from burns, fire, explosion, electrical shock, and carbon monoxide poisoning.

Only a qualified installer, service agent, or local gas supplier may install and service this product.

 **WARNING:** Do not store or use gasoline or other flammable vapors or liquids in the vicinity of this or any other appliance.

 **WARNING:** This appliance can be used with propane or natural gas. It is shipped from the factory adjusted for use with propane.

CARBON MONOXIDE POISONING: Early signs of carbon monoxide poisoning resemble the flu with headaches, dizziness, or nausea. If you have these signs, the heater may not be working properly. Get fresh air immediately! Have heater serviced. Some people are more affected by carbon monoxide than others. These include pregnant women, people with heart or lung disease, people who are anemic, those under the influence of alcohol, and those living in high altitudes.

NATURAL AND PROPANE/LP GAS: Natural and Propane/LP gases are odorless. An odor-making agent is added to the gas. The odor helps you detect a gas leak. However, the odor added to the gas can fade. Gas may be present even though no odor exists. Make certain you read and understand all warnings. Keep this manual for reference. It is your guide to operating this heater safely.

 **WARNING:** Any change to this fireplace/heater or its controls can be dangerous.

 **WARNING:** Do not use any accessories not approved for use with this heater.

 **WARNING:** Carefully supervise young children when they are in the room with the heater.

 **WARNING:** Heater becomes very hot when operating. Keep children and adults away from hot surfaces to avoid burns or clothing ignition. Heater will remain hot for a time after shutoff. Allow surfaces to cool before touching.

 **WARNING:** Keep the appliance area clear and free from combustible materials, gasoline, and other flammable vapors and liquids.

 **WARNING:** Due to high temperatures, locate this appliance out of traffic and away from furniture and draperies.

 **WARNING:** Do not place clothing or other flammable material on or near the appliance. Never place any objects in the heater.

CALIFORNIA PROPOSITION 65

Fuels used in gas or oil fired appliances and the products of combustion of such fuels contain chemicals known to the state of California to cause cancer, birth defects or other reproductive harm. This product contains chemicals, including lead and lead compounds, known to the state of California to cause cancer, birth defects or other reproductive harm. ***Wash hands after handling.***



SAFETY INFORMATION

1. This appliance is only for use with the type of gas indicated on the rating plate. This appliance is not convertible for use with other gases.
2. Do not place propane/LP supply tank(s) inside any structure. Locate propane/LP supply tank(s) outdoors.
3. If you smell gas
 - shut off gas supply
 - do not try to light any appliance
 - do not touch any electrical switch; do not use any phone in your building
 - immediately call your gas supplier from a neighbor's phone. Follow the gas supplier's instructions
 - if you cannot reach your gas supplier, call the fire department
4. This fireplace shall not be installed in a bedroom or bathroom.
5. Do not use this fireplace as a wood-burning fireplace. Use only the logs provided with the fireplace.
6. Do not add extra logs or ornaments such as pine cones, vermiculite or rock wool. Using these added items can cause sooting. Do not add lava rock around base. Rock and debris could fall into the control area of fireplace.
7. This fireplace is designed to be smokeless. If logs ever appear to smoke, turn off fireplace and call a qualified service person. Note: During initial operation, slight smoking could occur due to log curing and fireplace burning manufacturing residues.
8. To prevent the creation of soot, follow the instructions in Cleaning and Maintenance, page 32.
9. Before using furniture polish, wax, carpet cleaner or similar products, turn fireplace off. If heated, the vapors from these products may create a white powder residue within burner box or on adjacent walls or furniture.
10. This fireplace needs fresh air ventilation to run properly. This fireplace has an Oxygen Depletion Sensing (ODS) safety shutoff system. The ODS shuts down the fireplace if not enough fresh air is available. See Air for Combustion and Ventilation, page 9-11. If fireplace keeps shutting off, see Troubleshooting, page 34.
11. Do not run fireplace
 - where flammable liquids or vapors are used or stored.
 - under dusty conditions.
12. Do not use this fireplace to cook food or burn paper or other objects.
13. Never place any objects in the fireplace or on logs.
14. Do not use fireplace if any part has been under water. Immediately call a qualified service technician to inspect the room fireplace and to replace any part of the control system and any gas control which has been under water.
15. Turn off and unplug fireplace and let cool before servicing. Only a qualified service person should service and repair fireplace.
16. Operating fireplace above elevations of 4,500 feet could cause pilot outage.
17. Do not operate fireplace if log is broken. Do not operate fireplace if log is chipped (dime-sized or larger).
18. To prevent performance problems, do not use propane/LP fuel tank of less than 100 lb. capacity.
19. Provide adequate clearances around air openings.

QUALIFIED INSTALLING AGENCY

Only a qualified agency should install and replace gas piping, gas utilization equipment or accessories, and repair and equipment servicing. The term "qualified agency" means any individual, firm, corporation, or company that either in person or through a representative is engaged in and is responsible for:

a) Installing, testing, or replacing gas piping or

b) Connecting, installing, testing, repairing, or servicing equipment; that is experienced in such work; that is familiar with all precautions required; and that has complied with all the requirements of the authority having jurisdiction.

PRODUCT IDENTIFICATION

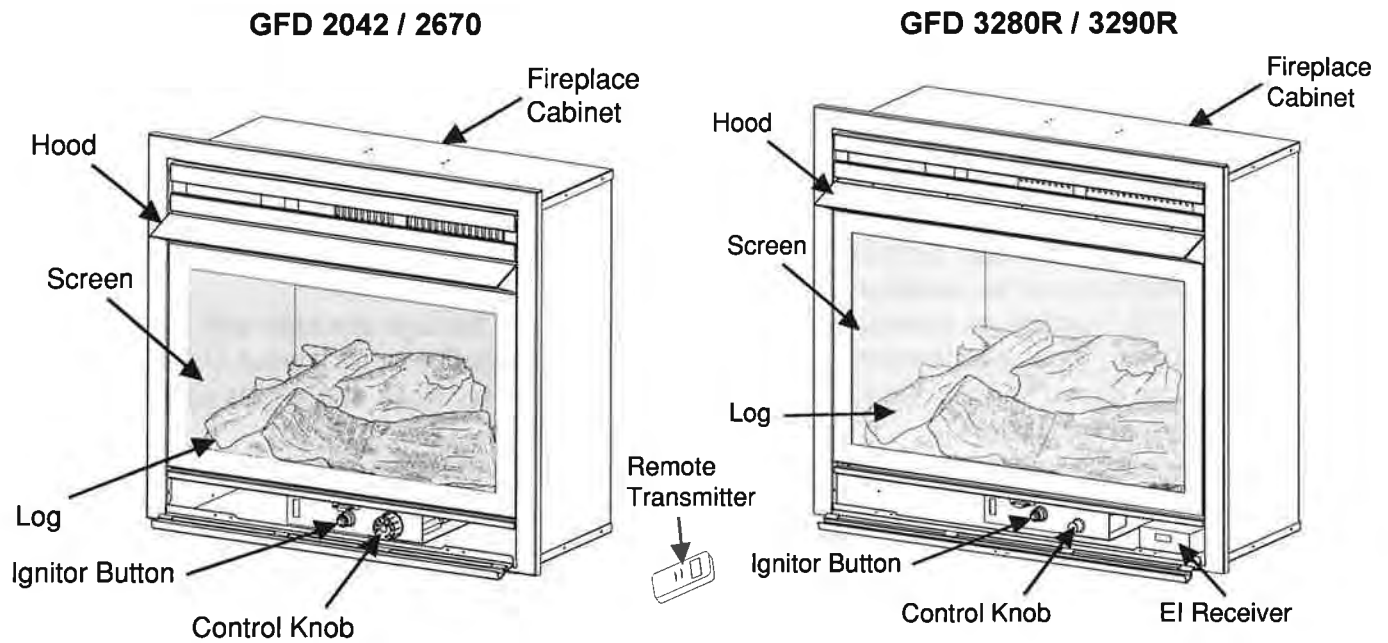
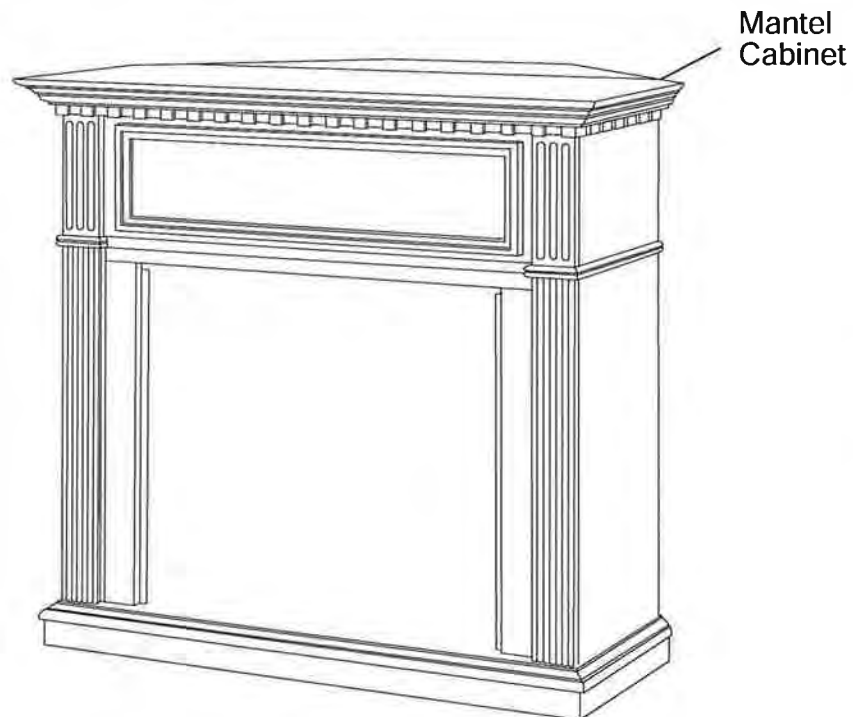

Fig. 1 - Vent-Free Dual Fuel Fireplace



NOTE: The fireplace is installed into the mantel through the front opening of the mantel cabinet.

⚠ WARNING: This fireplace is designed for use with the mantel cabinet provided. Installing the fireplace cabinet without the provided mantel or substituting another mantel will void the warranty and could result in property damage and personal injury.

PRODUCT FEATURES

SAFETY PILOT

This heater has a pilot with an Oxygen Depletion Sensing (ODS) safety shutoff system. The ODS/pilot shuts off the heater if there is not enough fresh air and cuts off main burner gas in the event of flame out.

ELECTRIC PUSH BUTTON IGNITION SYSTEM

This heater is equipped with an electronic piezo control system. This system requires one AAA battery (provided).

THERMOSTAT HEAT CONTROL

The control automatically cycles the burner on and off to maintain a desired room temperature. See page 24.

DUAL FUEL CAPABILITY

Your heater is equipped to operate on either propane or natural gas. The heater is shipped from the factory ready for connecting to propane. The heater can easily be changed to natural gas by having your qualified installer follow the instructions on page 17 and the markings on the heater.

BLOWER KIT (OPTIONAL)

The blower kit helps to distribute the warmed air into the space more rapidly.

State of Massachusetts: The installation must be made by a licensed plumber or gas fitter in the Commonwealth of Massachusetts. Sellers of unvented propane or natural gas-fired supplemental room heaters shall provide to each purchaser a copy of 527 CMR 30 upon sale of the unit.

In the State of Massachusetts, unvented propane or natural gas-fired space heaters shall be prohibited in bedrooms and bathrooms.

In the State of Massachusetts the gas cock must be a T-handle type. The State of Massachusetts requires that a flexible appliance connector cannot exceed three feet in length.

LOCAL CODES

Install and use heater with care. Follow all codes. In the absence of local codes, use the latest edition of The National Fuel Gas Code, ANSI Z223.1, also known as NFPA 54*.

*Available from:

American National Standard Institute, Inc.
1430 Broadway
New York, NY 10018

National Fire Protection Association, Inc.
1 Batterymarch Park
Quincy, MA 02269-9101

This heater is designed for vent-free operation. State and local codes in some areas prohibit the use of vent-free heaters.

UNPACKING

1. Remove fireplace cabinet and hood from carton. Log is wrapped and inside fireplace. Do not remove at this time.
2. Remove all protective packaging applied to fireplace for shipment.
3. Make sure your fireplace includes one hardware packet.
4. Check fireplace for any shipping damage. If fireplace is damaged, call our Technical service department, at 1-814-643-1775. Please do not return it to the store.

HOOD ASSEMBLY (IF REQUIRED)

WARNING: Always have screen in place before operating fireplace. This prevents excessive temperatures on fireplace surfaces.

WARNING: Failure to position the parts in accordance with these diagrams or failure to use only parts specifically approved with this fireplace may result in property damage or personal injury.

Tools Required:

• Phillips screwdriver • scissors

1. If equipped, lift fireplace screen up and pull out to remove (See Fig 2). Set screen aside until installation has been completed.
2. Cut two plastic straps to remove log from firebox cavity. Set log aside.
3. An optional blower is available. See Accessories, page 38. Install optional blower now. Follow installation instructions provided with blower.
4. Locate four black Phillips sheet metal screws in hardware packet.
5. Slide hood between louver and firebox top and align screw holes.
6. Insert screws as shown in Figure 3. Tighten screws firmly.

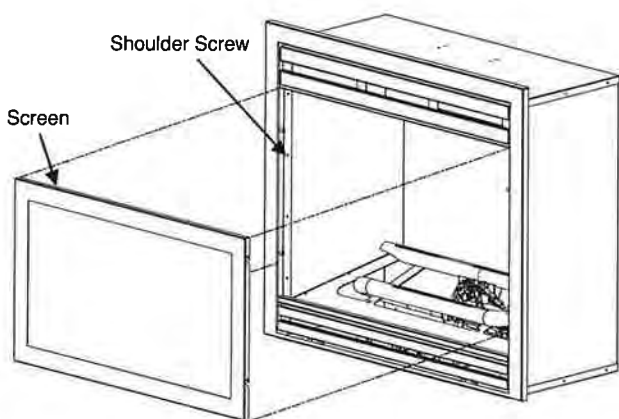

Fig. 2 - Removing and Installing Screen

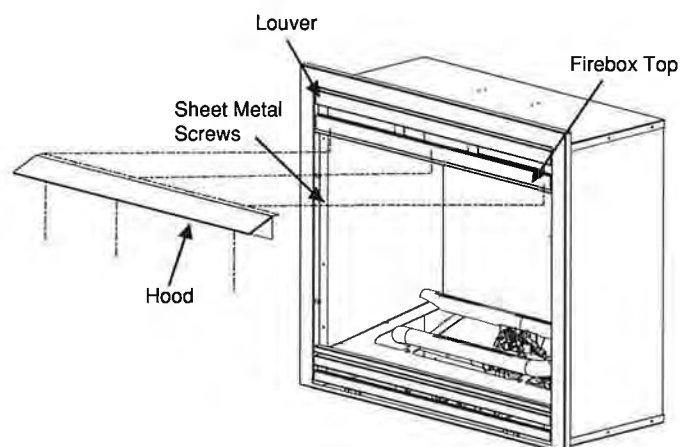
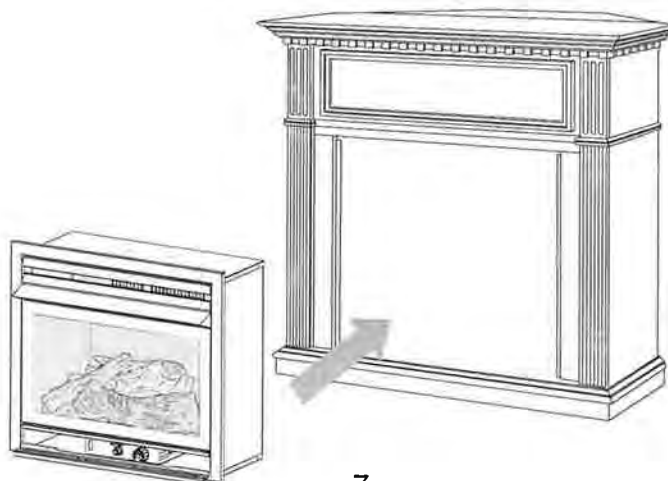

Fig. 3 - Assembling Hood (If Required)

Carefully lift the insert through the center opening in the front of the fireplace. Slide the insert back through the opening until the metal trim makes contact with the front of the mantel.



PREPARING FOR INSTALLATION

AIR FOR COMBUSTION AND VENTILATION

⚠ WARNING: This heater shall not be installed in a room or space unless the required volume of indoor combustion air is provided by the method described in the *Nation Fuel Gas Code, ANSI Z223.1/NFPA 54*, the *International Fuel Gas Code*, or applicable local codes.

PRODUCING ADEQUATE VENTILATION

All spaces in homes fall into one of the three following ventilation classifications:

1. Unusually Tight Construction
2. Unconfined Space
3. Confined Space

The information on pages 9 through 11 will help you classify your space and provide adequate ventilation.

Confined and Unconfined Space

A confined space as a space whose volume is less than 50 cu. ft. per 1,000 BTU/hr (4.8 m³ per kw) of the aggregate input rating of all appliances installed in that space and an unconfined space as a space whose volume is not less than 50 cu. ft. per 1,000 BTU/hr (4.8 m³ per kw) of the aggregate input rating of all appliances installed in that space. Rooms connecting directly with the space in which the appliances are installed*, through openings not furnished with doors, are considered a part of the unconfined space.

This heater shall not be installed in a confined space or unusually tight construction unless provisions are provided for adequate combustion and ventilation air.

* Adjoining rooms are connecting only if there are doorless passageways or ventilation grills between them.

Unusually Tight Construction

The air that leaks around doors and windows may provide enough fresh air for combustion and ventilation. However, in buildings of unusually tight construction, you must provide additional fresh air.

Unusually tight construction is defined as construction where:

- a) walls and ceilings exposed to the outside atmosphere have a continuous water vapor retarder with a rating of one perm (6x10⁻¹¹kg per pa-sec-m²) or less with openings gasketed or sealed and
- b) weather stripping has been added on windows that can be opened and on doors and
- c) caulking or sealants are applied to areas such as joints around window and door frames, between sole plates and floors, between wall-ceiling joints, between wall panels, at penetrations for plumbing, electrical, and gas lines, and at other openings.

If your home meets all of the three criteria above, you must provide additional fresh air. See "Ventilation Air From Outdoors" (page 10). If your home does not meet all of the three criteria above, proceed to "Determining Fresh-Air Flow For Heater Location".

PREPARING FOR INSTALLATION

DETERMINING FRESH-AIR FLOW FOR HEATER LOCATION

Determining if You Have a Confined or Unconfined Space

Use this worksheet to determine if you have a confined or unconfined space.

Space: Includes the room in which you will install heater plus any adjoining rooms with doorless passageways or ventilation grills between the rooms.

1. Determine the volume of the space $\text{Length} \times \text{Width} \times \text{Height} = \text{cu. ft. (volume of space)}$
Example: Space size 20 ft. (length) \times 16 ft.(width) \times 8 ft. (ceiling height) = 2560 cu. ft. (volume of space)

If additional ventilation to adjoining room is supplied with grills or openings, add the volume of these rooms to the total volume of the space.

2. Divide the space volume by 50 cu. ft. to determine the maximum BTU/hr the space can support.
_____ (volume of space) \div 50 cu. ft. = (Maximum BTU/hr the space can support)
Example: 2560 cu. ft. (volume of space) \div 50 cu. ft. = 51.2 or 51,200 (maximum BTU/hr the space can support)

3. Add the BTU/hr of all fuel burning appliances in the space.

Vent-free heater _____ BTU/hr

Gas water heater* _____ BTU/hr

Gas furnace _____ BTU/hr

Vented gas heater _____ BTU/hr Example:

Gas heater logs _____ BTU/hr Gas water heater 30,000 BTU/hr

Other gas appliances*+ _____ BTU/hr Vent-free heater + 26,000 BTU/hr

Total = _____ BTU/hr Total = 56,000 BTU/hr

*Do not include direct-vent gas appliances. Direct-vent draws combustion air from the outdoors and vents to the outdoors.

4. Compare the maximum BTU/hr the space can support with the actual amount of BTU/hr used.

_____ BTU/hr (maximum the space can support)

_____ BTU/hr (actual amount of BTU/hr used).

Example : 51,200 BTU/hr (maximum the space can support) 56,000 BTU/hr (actual amount of BTU/hr used)

The space in the above example is a confined space because the actual BTU/hr used is more than the maximum BTU/hr the space can support.

You must provide additional fresh air. Your options are as follows:

- a) Rework worksheet, adding the space of an adjoining room. If the extra space provides an unconfined space, remove door to adjoining room or add ventilation grills between rooms. See "Ventilation Air From Inside Building," page 11.
- b) Vent room directly to the outdoors. See "Ventilation Air From Outdoors", page 11.
- c) Install a lower BTU/hr heater if lower BTU/hr size makes room unconfined. If the actual BTU/hr used is less than the maximum BTU/hr the space can support, the space is an unconfined space. You will need no additional fresh air ventilation.

PREPARING FOR INSTALLATION

Ventilation Air From Inside Building

This fresh air would come from adjoining unconfined space. When ventilating to an adjoining unconfined space, you must provide two permanent openings: one within 12 in. of the wall connecting the two spaces (see options 1 and 2, Fig. 4). You can also remove door into adjoining room (see option 3, Fig. 4). Follow the National Fuel Gas Code NFPA 54/ANS Z223.1. Air for Combustion and Ventilation for required size of ventilation grills or ducts.

Ventilation Air From Outdoors

Provide extra fresh air by using ventilation grills or duct. You must provide two permanent openings: one within 12 in. of the ceiling and one within 12 in. of the floor. Connect these items directly to the outdoors or spaces open to the outdoors. These spaces include attics and crawl spaces. Follow the National Fuel Gas Code NFPA 54/ANS Z223.1. Air for Combustion and Ventilation for required size of ventilation grills or ducts.

IMPORTANT: Do not provide openings for inlet or outlet air into attic if attic has a thermostat-controlled power vent. Heated air entering the attic will activate the power vent. Rework worksheet, adding the space of the adjoining unconfined space. The combined spaces must have enough fresh air to supply all appliances in both spaces.

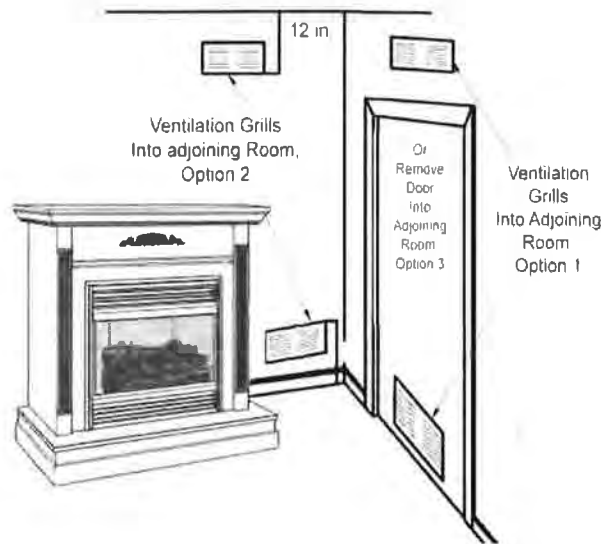

Fig. 4 - Ventilation Air from Inside Building

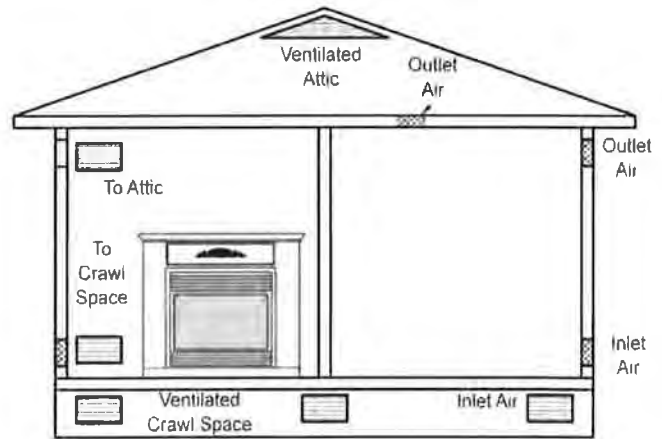

Fig. 5 - Ventilation Air from Outdoors

INSTALLATION

⚠ WARNING: Do not attempt to access or change the setting of the fuel selection means.

Access to and adjustment of the fuel selection means must only be performed by a qualified service person when connecting this appliance to a specified fuel supply at the time of installation.

Change of the selector setting to other than the fuel type specified at the time of installation could damage this appliance and render it inoperable.

The installer shall replace the access cover before completing the installation and operating this appliance.

⚠ NOTICE: This heater is intended for use as supplemental heat. Use this heater along with your primary heating system. Do not install this heater as your primary heat source. If you have a central heating system, you may run system's circulating blower while using heater. This will help circulate the heat throughout the house.

⚠ WARNING: A qualified technician must install heater. Follow all local codes.

⚠ WARNING: Never install the heater:

- in a bedroom or bathroom
- in a recreational vehicle
- where curtains, furniture, clothing, or other flammable objects are less than 42 in. from the front, top or sides of the heater.
- in high traffic areas
- in windy or drafty areas

⚠ WARNING: Maintain the minimum clearances. If possible, provide greater clearances from the floor, ceiling, and adjoining wall than required.

CAUTION: This heater creates warm air currents. These currents move heat to wall surfaces next to heater. Installing heater next to vinyl or cloth wall coverings or operating heater where impurities (such as tobacco smoke, aromatic candles, cleaning fluids, oil or kerosene lamps, etc.) in the air exist, may cause walls to discolor.

IMPORTANT: Vent-free heaters add moisture to the air. Although this is beneficial, installing heater in rooms without enough ventilation air may cause mildew to form from too much moisture. See Air for Combustion and Ventilation, pages 9 through 11.

CHECK GAS TYPE

Be sure your gas supply is right for your heater.

CLEARANCES TO COMBUSTIBLES

Carefully follow the instructions below. This heater is designed to sit directly on the mantel base.

IMPORTANT: Maintain the minimum clearances shown in Figure 6 on page 12. If you can, provide greater clearances from floor, ceiling and joining wall.

INSTALLATION

FIREPLACE CLEARANCES

- ⚠ CAUTION:** If you install the fireplace in a home garage
- fireplace pilot and burner must be at least 18" above floor.
 - locate fireplace where moving vehicle will not hit it.

For convenience and efficiency, install fireplace

- where there is easy access for operation, inspection and service
- in coldest part of room
- If this appliance is to be installed directly on carpeting, tile or other combustible material, other than wood flooring, the appliance must be installed on a metal or wood panel extending the full width and depth of the appliance.

An optional blower kit is available from your retailer. See Accessories, page 38. If planning to use blower, follow instructions provided with blower for power source.

Minimum Clearances For Side Combustible Material, Side Wall and Ceiling

A. Clearances from the side of the fireplace cabinet to any combustible material and wall should follow diagram in Figure 6.

B. Clearances from the top of the fireplace opening to the ceiling should not be less than 36".

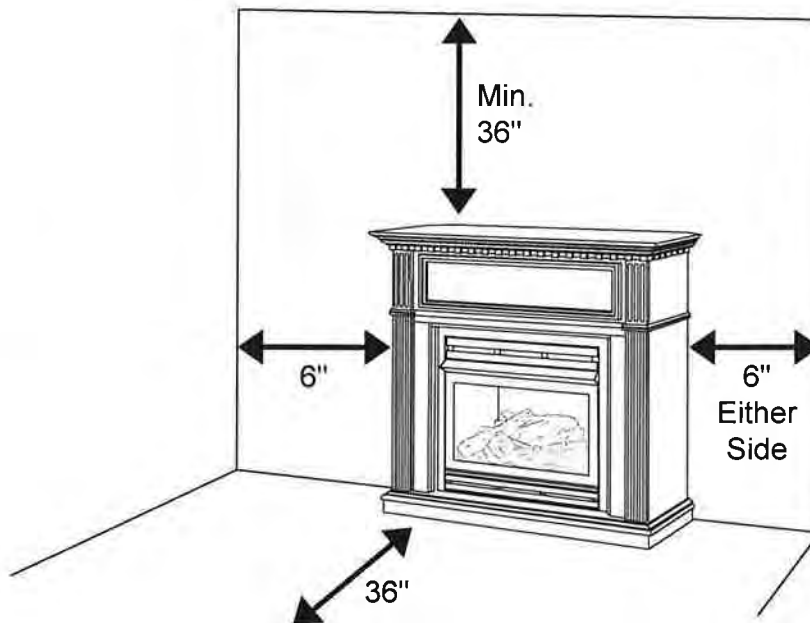

Fig. 6 - Minimum Clearance to Combustible Material

- This firebox is only for use with the mantel provided.

INSTALLATION

⚠ WARNING: This optional blower is equipped with a three-prong (grounding) plug for your protection against shock hazard and must be plugged directly into a properly grounded three-prong receptacle.

Firebox must be disconnected from gas supply and removed from mantel before installing fan accessory. Contact a qualified service person to do this.

BLOWER INSTALLATION (OPTIONAL)

1. Remove Blower Access Panel.
2. Mount Blower (B) onto bottom of Fireplace Top using 4 screws (F).
3. Attach Power Cord (A) to Blower Access Panel.
4. Attach Temperature Sensor (C) to the Combustion Top using 2 sheet metal screws.

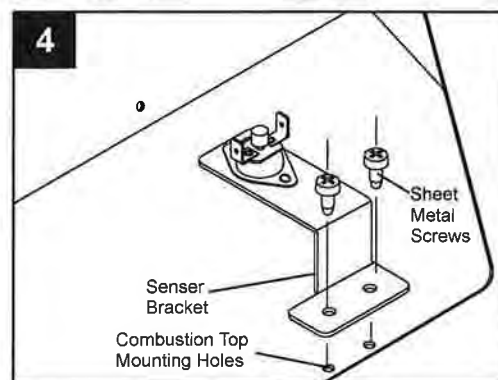
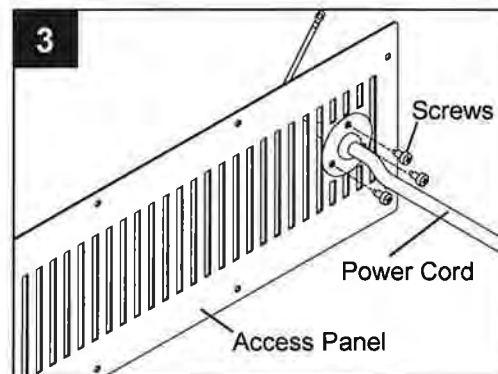
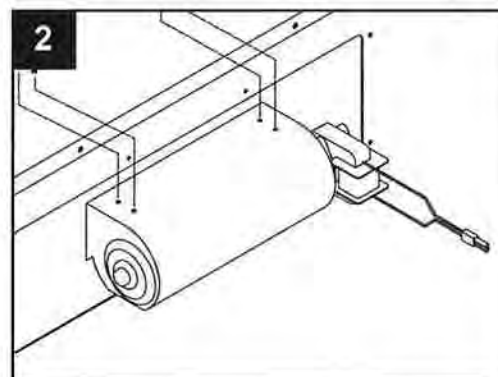
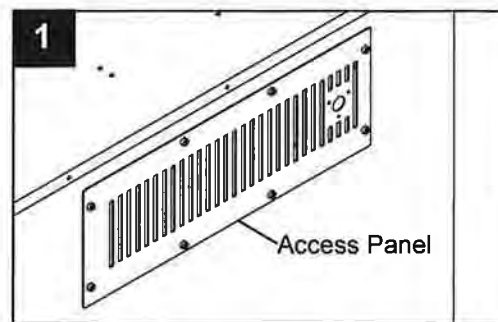

INSTALLATION

5. Important: Insert the wires marked with AUTO, OFF and MAN into line slot on the right corner. Keep wires close to the bottom.

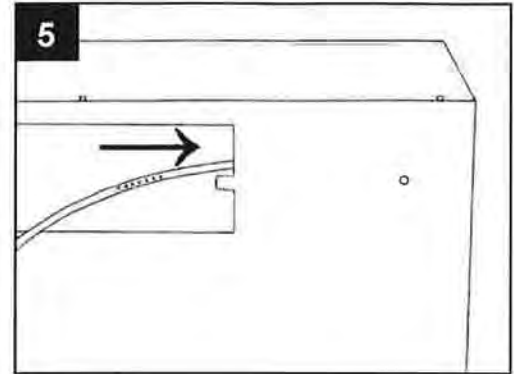

6. Insert two wires' female plugs marked with T1 and T2 (black and yellow) into two male ports on Temperature Sensor.

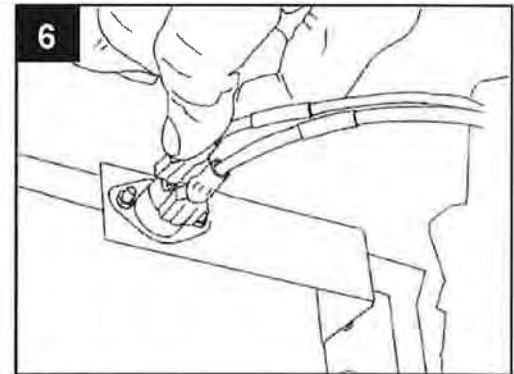

7. Insert the female plug on the white power supply wire (marked with P1), into the corresponding male port (marked with P1).

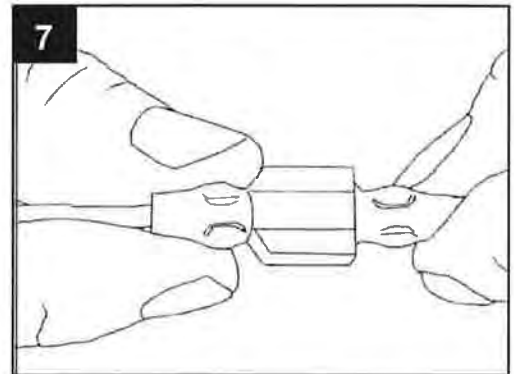

8. Insert the female plug (marked with P2) into the corresponding male port, which is on the black power supply wire (marked with P2).

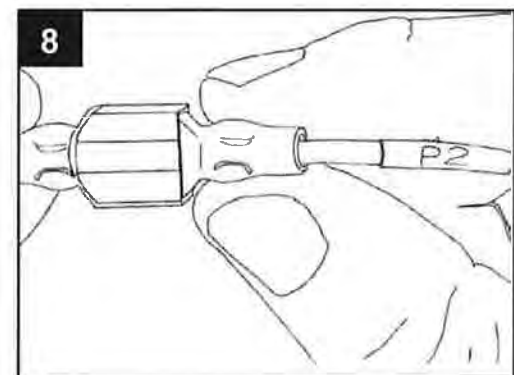

INSTALLATION

9. Insert the blower link (male plug) into the power link (female port).

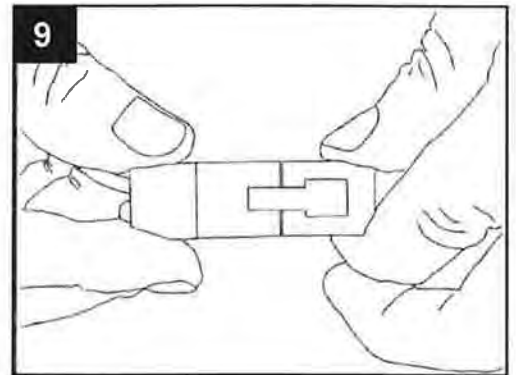

10. **Important:** Bind wires with cable ties (G), and attach cable ties (G) in holes on back of Outer Casing. Attach one in hole near the top and one in hole near the bottom.

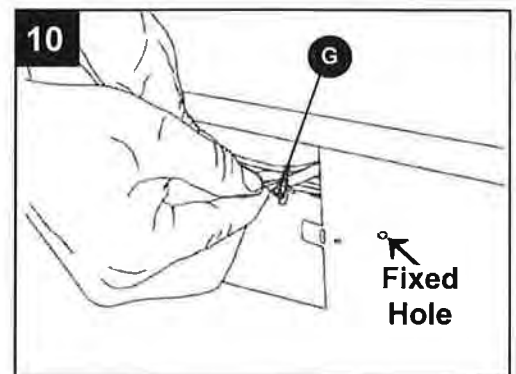

11. Insert AUTO, OFF, MAN wires through the Rocker Switch opening.

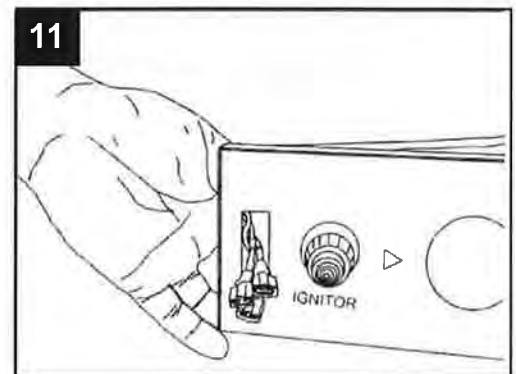

12. Connect AUTO, OFF, MAN wires to the three corresponding male ports on the Rocker Switch (E). Match the "Auto" wire to the symbol "≡" and the "Man" wire to the symbol "—" on the rocker switch (E).

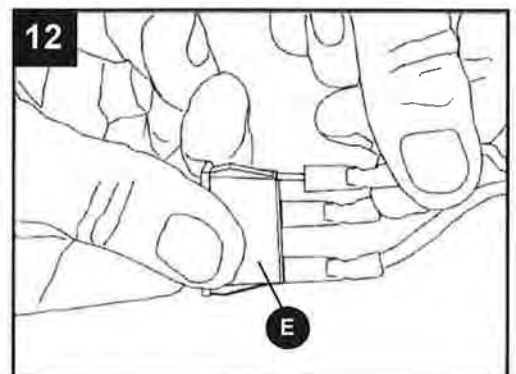

INSTALLATION

13. Push Rocker Switch (E) into Control Panel and secure.

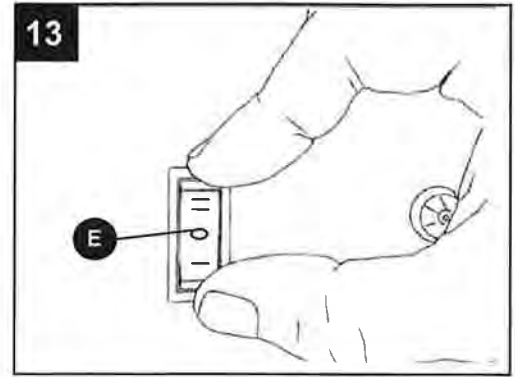

14. Check that all wires are secure and reattach Blower Access Panel to Outer Casing. Capture the Green Ground wire between the Access Plate and Outer Casing with the upper right screw.

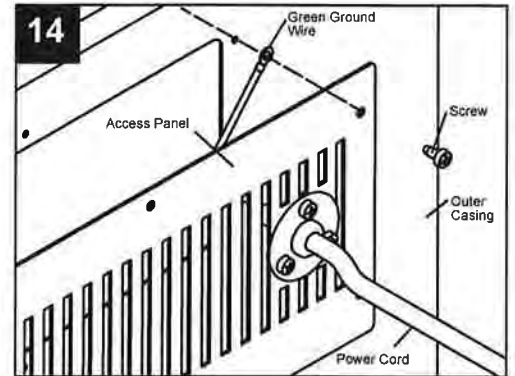

Electrical Wiring Diagram

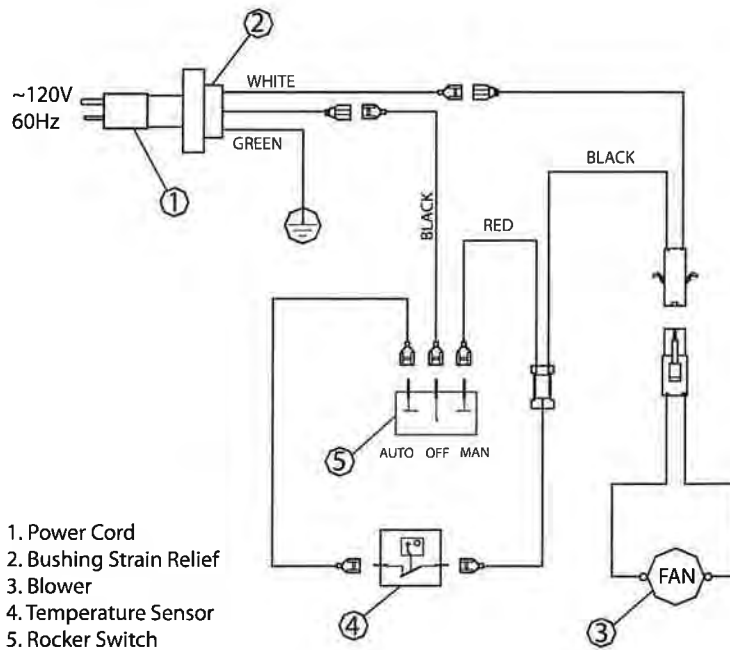

NOTE: If any of the original wire as supplied with the appliance must be replaced, it must be replaced with a wire of at least an equal temperature rating.

⚠ CAUTION: Label all wires prior to disconnection when servicing controls. Wiring errors can cause improper and dangerous operation.

Verify proper operation after servicing.

INSTALLATION

GAS SELECTION INSTRUCTIONS

⚠ WARNING: This appliance can be used with propane or natural gas. It is shipped from the factory adjusted for use with propane.

CAUTION: The knob to the gas selection means shall not be accessed or adjusted while the appliance is in operation.

CAUTION: Two gas line installations at the same time are prohibited. The access plate to simple switching means shall not be opened while heater is in operation.

Installation and adjustments shall be made by a qualified technician only.

NOTE: If you are connecting this appliance to propane do not make any adjustments. Proceed to installing the gas line as instructed in the Owner's Manual.

Convert to natural gas:

Step 1 - Converting the regulator

Unscrew the cap on top of the pressure regulator by turning it counter clockwise. Unscrew the plunger pin from the regulator cap by turning it counter clockwise. Flip the plunger pin 180 degrees and screw it back into the regulator cap by turning it clockwise. Replace the cap by turning it clockwise back onto the regulator. Make sure the plunger pin and cap are finger tight. (See Fig. 7)

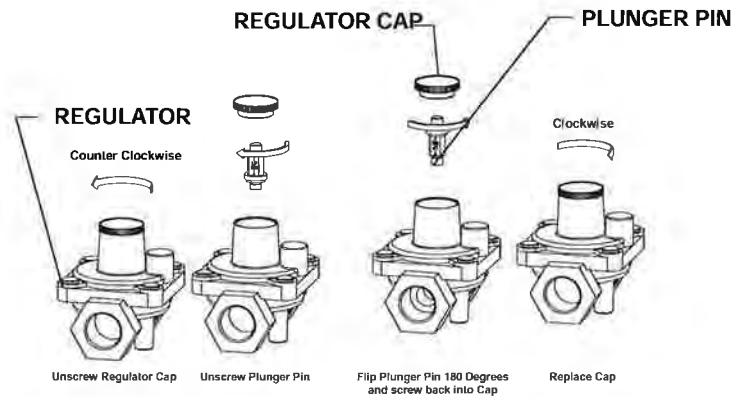

Fig. 7 - Regulator Conversion

Step 2 - Adjust the gas selector valve

Push in on the selector valve Knob and rotate the knob counter clockwise until it stops. Release the knob (See Fig. 8)

Do not operate the appliance between locked positions.

Reverse steps 1 and 2 to convert back to propane gas.

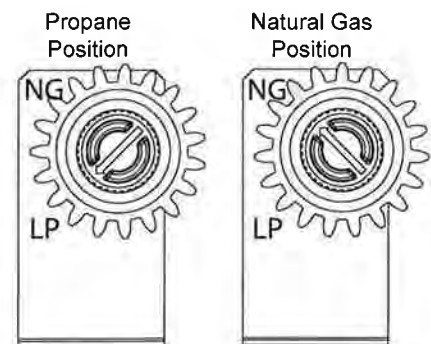

Fig. 8 - Selector Valve

INSTALLATION

CONNECTING TO GAS SUPPLY

⚠ WARNING: A qualified service technician must connect heater to gas supply. Follow all local codes.

CAUTION: Never connect heater directly to the gas supply. This heater requires an external regulator (not supplied). The external regulator between the gas supply and heater must be installed. Gas supplier provides external regulator for natural gas.

⚠ WARNING: Never connect heater to private (non-utility) gas wells. This gas is commonly known as wellhead gas.

The installer must supply an external regulator for liquid propane. The external regulator is provided by the gas supplier for natural gas. The external regulator will reduce incoming gas pressure. You must reduce incoming gas pressure to between 11 and 14 in. of water column for propane and between 5 and 10.5 in. of water column for natural gas. If you do not reduce incoming gas pressure, heater regulator damage could occur. Install external regulator with the vent pointing down as shown in Fig. 6. Pointing the vent down protects it from freezing rain or sleet.

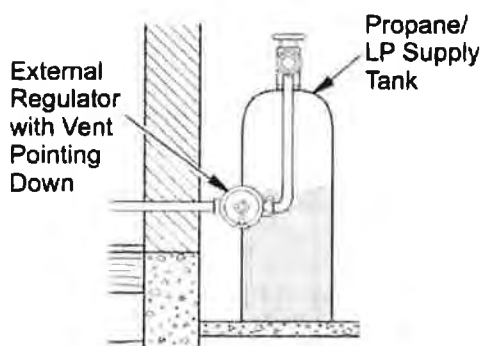

Fig. 9 - Regulator Conversion

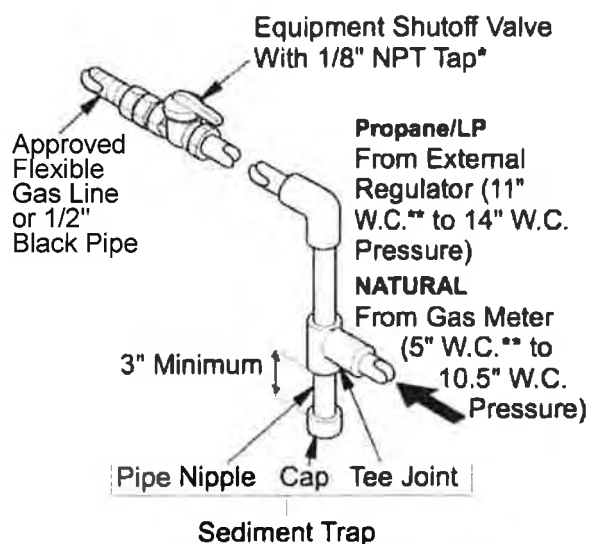

Fig. 10 - Gas Connection

* Purchase the optional equipment shutoff valve from your local Home Center store.

⚠ CAUTION: Use only new black iron or steel pipe. Internally tinned copper tubing may be used in certain areas. Check your local codes. Use pipe of ½ in. diameter or greater to allow proper volume gas to heater. If pipe is too small, loss of pressure will occur. Installation must include an equipment shutoff valve, union, and plugged 1/8-in. NPT tap. Locate NPT tap within reach for test gauge hook up. NPT tap must be upstream from heater (See Fig. 10).

IMPORTANT: Install equipment shutoff valve in an accessible location. The equipment shutoff valve is for turning on or shutting off the gas to the appliance. Apply pipe joint sealant lightly to male threads. This will prevent excess sealant from going into pipe. Excess sealant in pipe could result in clogged heater valves.

INSTALLATION

⚠ CAUTION: Use pipe joint sealant that is resistant to gas (PROPANE or NG). We recommend that you install a sediment trap in a supply line as shown in Fig. 10. Locate sediment trap where it is within reach for cleaning and not likely to freeze. Install in the piping system between fuel supply and heater. A sediment trap traps moisture and contaminants. This keeps them from going into heater controls. If sediment trap is not installed or is installed incorrectly, heater may not run properly.

⚠ CAUTION: Avoid damage to regulator. Hold gas regulator with wrench when connecting into gas piping and/or fittings. NG Models: 5 in. to 10.5 in. W.C. Gas supplier provides external regulator for natural gas.

Installation Items Needed (Not Provided)

- 8" Adjustable Wrench
- 8" Pipe Wrench
- Flexible Gas Line (24" Min.) or 1/2" Black Pipe
- 90 Deg. 3/8 NPT x 3/8" Flare Fitting or 3/8" Street Elbow
- Sealant (Resistant to Propane (LP) Gas)
- Shut Off Valve

1) A variety of options are possible for routing the Gas Connection Lines depending on where your Gas Supply line is located. Install the 3/8" Fitting to the Fireplace Cabinet Regulator using Sealant and direct the attachment and either left or right toward the Gas Supply Line.

NOTICE: Most building codes do not permit concealed gas connections. Check your local building code prior to using a Flexible Gas Line for this installation.

2) Install the Gas Line to the 90 Deg. fitting and attach to the Shut Off Valve. It may be necessary to cut and access hole in the side or bottom of the Mantel Cabinet depending on your particular connection.

3) Check all connections for gas leaks.

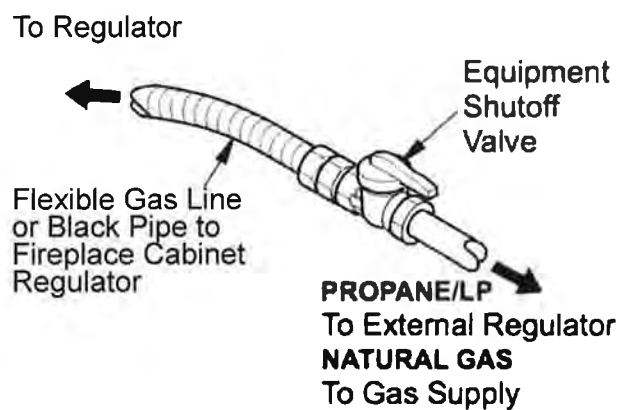
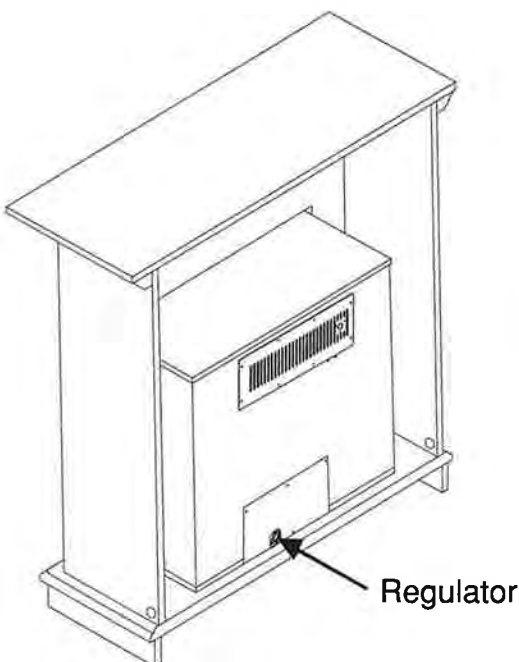

Fig. 11 - Attaching Flexible Gas Line to Equipment Shutoff Valve

ASSEMBLING LOGS

GFD 2042 / 2670

⚠ WARNING: Failure to position the parts in accordance with these diagrams or failure to use only parts specifically approved with this heater may result in property damage or personal injury.

⚠ CAUTION: After installation and periodically thereafter, check to ensure that no yellow flame comes in contact with any log. With the heater set to High, check to see if yellow flames contact any log. If so, reposition logs according to the log installation instructions in this manual. Yellow flames contacting logs will create soot.

It is very important to install the logs exactly as instructed. Do not modify logs. Use only logs supplied with heater. Each log is marked with a number. This number will help you identify the logs when installing.

Provided Logs: 5

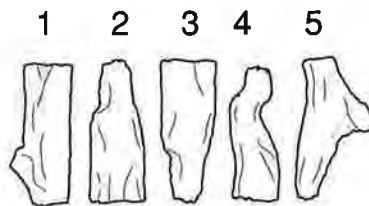

Installing Log #1

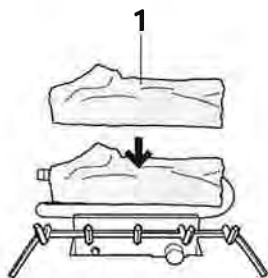

1. Insert log #1 onto the rear row of pins on the base pan.

Installing Log #2

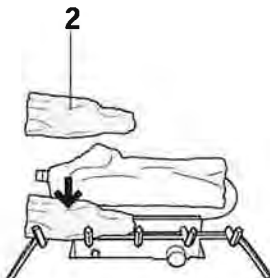

2. Insert log #2 onto the front left pin on the base pan.

Installing Log #3



3. Insert log #3 onto the front right pin on the base pan.

Installing Log #4



4. Insert log #4 onto the left pin of log #1 and the pin of log #2.

Installing Log #5



5. Insert log #5 onto the right pin of log #1 and the pin of log #3.

ASSEMBLING LOGS

GFD 3280R / 3290R

⚠ WARNING: Failure to position the parts in accordance with these diagrams or failure to use only parts specifically approved with this heater may result in property damage or personal injury.

⚠ CAUTION: After installation and periodically thereafter, check to ensure that no yellow flame comes in contact with any log. With the heater set to High, check to see if yellow flames contact any log. If so, reposition logs according to the log installation instructions in this manual. Yellow flames contacting logs will create soot.

It is very important to install the logs exactly as instructed. Do not modify logs. Use only logs supplied with heater. Each log is marked with a number. This number will help you identify the logs when installing. After installing logs, add decorative cinders around the grate base, do not place any decorative cinders on logs or burner.

Provided Logs: 5

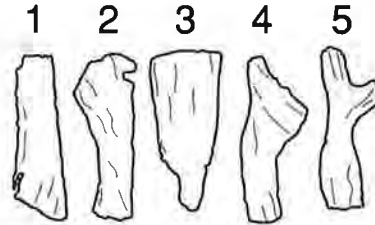

Installing Log #1

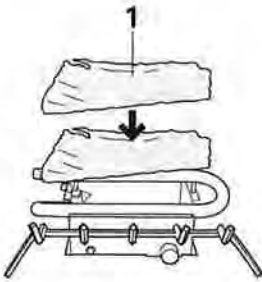

1. Insert log #1 onto the rear brackets of the base pan.

Installing Log #2

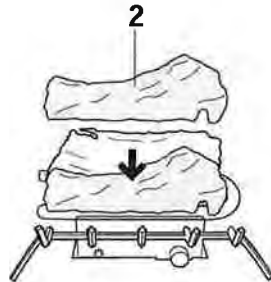

2. Insert log #2 onto the middle row of pins on the base pan.

Installing Log #3

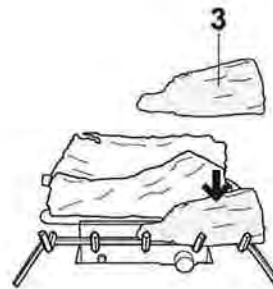

3. Insert log #3 onto the front right pin of the base pan.

Installing Log #4



4. Insert log #4 onto the front left pin of the base pan.

Installing Log #5



5. Insert log #5 onto the left pins of log #1 & #2.

INSTALLATION

CHECKING GAS CONNECTIONS

⚠ WARNING: Test all gas piping and connections for leaks after installing or servicing. Correct all leaks immediately.

⚠ WARNING: Never use an open flame to check for a leak. Apply a mixture of liquid soap and water to all joints. If bubbles form, there may be a leak. Correct all leaks immediately.

Pressure Testing Gas Supply Piping System Test Pressures In Excess Of 1/2 PSIG (3.5kPa)

1. Disconnect heater with its appliance main gas valve (control valve) and equipment shutoff valve from gas supply piping system. Pressures in excess of 1/2 PSIG will damage heater regulator.
2. Cap off open end of gas pipe where equipment shutoff valve was connected.
3. Pressurize supply piping system by either using compressed air or opening gas supply tank valve.
4. Check all joints of gas supply piping system. Apply mixture of liquid soap and water to gas joints. If bubbles form, there may be a leak.
5. Correct all leaks immediately.
6. Reconnect heater and equipment shutoff valve to gas supply. Check reconnected fittings for leaks.

Test Pressures Equal To or Less Than 1/2 PSIG (3.5 kPa)

1. Close equipment shutoff valve (See Fig. 12).
2. Pressure supply piping system by either using compressed air or opening gas supply tank valve.
3. Check all joints from gas meter to equipment shutoff valve (See Fig.13). Apply mixture of liquid soap and water to gas joints. If bubbles form, there may be a leak.
4. Correct all leaks immediately.

Pressure Testing Heater Gas Connections

1. Open equipment shutoff valve (See Fig. 12).
2. Open gas supply tank valve.
3. Make sure control knob of heater is in the OFF position.
4. Check all joints from equipment shutoff valve to control valve (See Fig. 13). Apply mixture of liquid soap and water to gas joints. If bubbles form, there may be a leak.
5. Light heater (see Operation, page 23).
Check all other internal joints for leaks.
6. Turn off heater (see "To Turn Off Gas to Appliance," page 24).

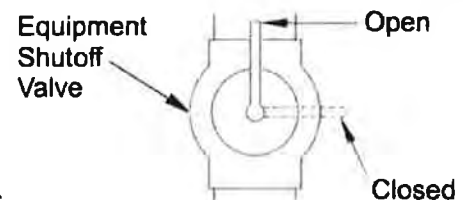
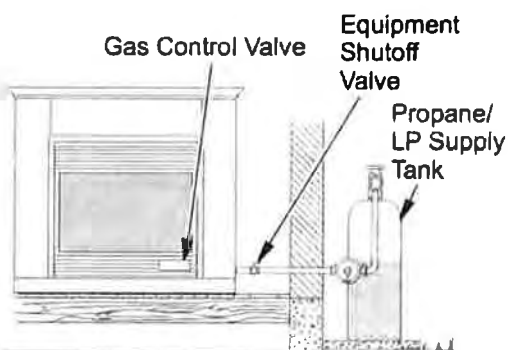
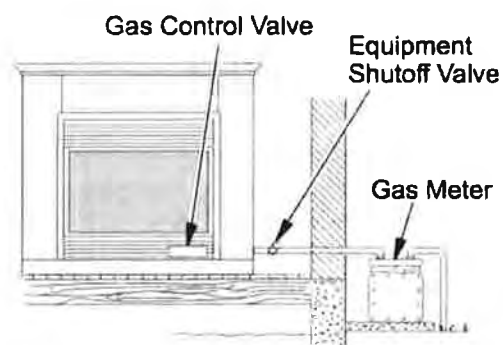

Fig. 12 - Equipment Shutoff Valve



**Fig. 13 - Checking Gas Joints
(Propane/LP Only)**



**Fig. 14 - Checking Gas Joints
(Natural Gas Only)**

OPERATION

FOR YOUR SAFETY READ BEFORE LIGHTING



WARNING: If you do not follow these instructions exactly, a fire or explosion may result causing property damage, personal injury or loss of life.

A. This appliance has a pilot which must be lighted by the electronic ignitor. When lighting the pilot, follow these instructions exactly.

B. **BEFORE LIGHTING** smell all around the appliance area for gas. Be sure to smell next to the floor because some gas is heavier than air and will settle on the floor.

WHAT TO DO IF YOU SMELL GAS



- Do not try to light any appliance.
- Do not touch any electrical switch; do not use any phone in your building.
- Immediately call your gas supplier from a neighbor's phone. Follow the gas supplier's instructions.
- If you cannot reach your gas supplier, call the fire department

C. Use only your hand to push in or turn the gas control knob. Never use tools. If the knob will not push in or turn by hand, don't try to repair it, call a qualified service technician. Forced or attempted repair may result in fire or explosion.

D. Do not use this appliance if any part has been under water. Immediately call a qualified service technician to inspect the appliance and to replace any part of the control system and any gas control which has been under water.

LIGHTING INSTRUCTIONS

Models GFD 2042 / 2670

1. STOP! Read the safety information as noted above.
2. Open the lower access panel located below the fireplace screen.
3. Turn control knob clockwise  to the "OFF" position (See Fig. 15).
4. Wait five (5) minutes to clear out any gas. Then smell for gas, including near the floor. If you smell gas, STOP! Follow "B" in the safety information as noted above. If you don't smell gas, go to the next step.
5. Turn control knob counterclockwise  to the "PILOT" position (See Fig. 16). Depress control knob.
6. With control knob depressed, push down on the ignitor button until the pilot lights. The pilot is located behind the fireplace screen, centered near the rear of the burner.
7. Keep control knob depressed for (30) seconds after pilot lights. Release control knob.

- If the control knob does not pop up when released, stop and immediately call a qualified service technician or gas supplier.
- If pilot goes out repeat steps 3 through 7. Wait (1) minute before attempting to light pilot again. If after several tries the pilot still goes out, turn the gas control knob clockwise  to the "OFF" position and call a qualified service technician.

8. Turn control knob counterclockwise  to desired setting.
9. Close lower access panel.

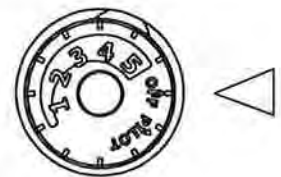
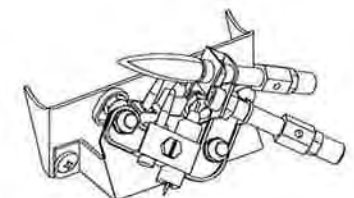

Fig. 15 - Control Knob



Note: Small Flame on
LP ODS Pilot

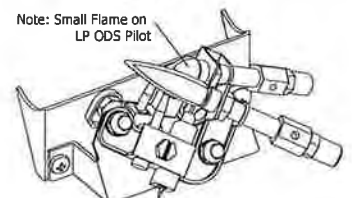

Fig. 16 - Pilot

OPERATION

Model GFD 3280R / 3290R

1. STOP! Read the safety information on the page before this.
2. Open the lower access panel located below the fireplace screen.

- Set receiver switch to "ON" position (See Fig. 17).

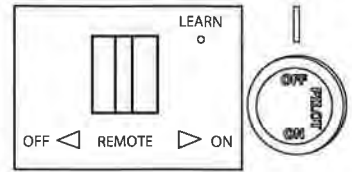

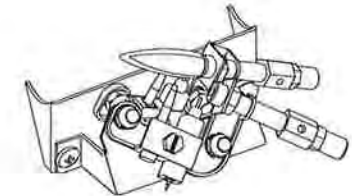

Fig. 17 - Receiver & Control Knob

3. Turn control knob clockwise  to the "OFF" position (See Fig. 17).
4. Wait five (5) minutes to clear out any gas. Then smell for gas, including near the floor. If you smell gas, STOP! Follow "B" in the safety information on the page before this. If you don't smell gas, go to the next step.
5. Push in slightly and turn control knob counterclockwise  to the "PILOT" position (See Fig. 17). Depress control knob.
6. With control knob depressed, push down on the ignitor button until the pilot lights. The pilot is located behind the fireplace screen, centered near the rear of the burner (See Fig. 18).
7. Keep control knob depressed for (30) seconds after pilot lights. Release control knob.



Note: Small Flame on LP ODS Pilot

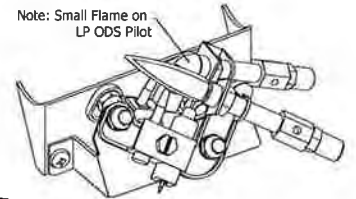



Fig. 18 - Pilot

- If the control knob does not pop up when released, stop and immediately call a qualified service technician or gas supplier.
- If pilot goes out repeat steps 3 through 7. Wait (1) minute before attempting to light pilot again. If after several tries the pilot still goes out, turn the gas control knob clockwise  to the "OFF" position and call a qualified service technician.

8. Turn control knob counterclockwise  to the "ON" position.
9. To use the included thermostatic remote control, set receiver switch to the "REMOTE" position (See Fig. 19). Press the ON button to turn on the remote to ignite the main burner. Refer to the remote control instruction manual on the next page for "MODE" and "SET" functions.

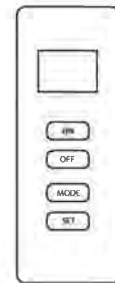



Fig.19 - Remote

TO TURN OFF GAS TO APPLIANCE

Models GFD 2042 / 2670

1. Open the lower access panel located under the fireplace screen.
2. Turn control knob clockwise  to the "OFF" position.
3. Close lower access panel.

Models GFD 3280R / 3290R

1. Set thermostat to the lowest setting.
2. Press the OFF button on the remote control.
3. Open the lower access panel located under the fireplace screen.
4. Push in slightly and turn control knob clockwise  to the "OFF" position.
5. Close lower access panel.

REMOTE CONTROL OPERATION

MULTI-FUNCTION WIRELESS REMOTE CONTROL SYSTEM FOR OPERATING A LATCHING SOLENOID VALVE, MANUALLY OR WITH A THERMOSTAT FUNCTION

IF YOU CANNOT READ OR UNDERSTAND THESE INSTALLATION INSTRUCTIONS DO NOT ATTEMPT TO INSTALL OR OPERATE

INTRODUCTION

This remote control system was developed to provide a safe, reliable, and user-friendly remote control system for gas heating appliances. The system is operated manually from the transmitter. The system operates on radio frequencies (RF) within a 20-foot range using non-directional signals. The system operates on one of 1,048,576 security codes that are programmed into the transmitter at the factory; the remote receiver's code must be matched to that of the transmitter prior to initial use.

Review COMMUNICATION SAFETY under GENERAL INFORMATION section. This safety feature shuts down the appliance when a potentially unsafe condition exists.

TRANSMITTER

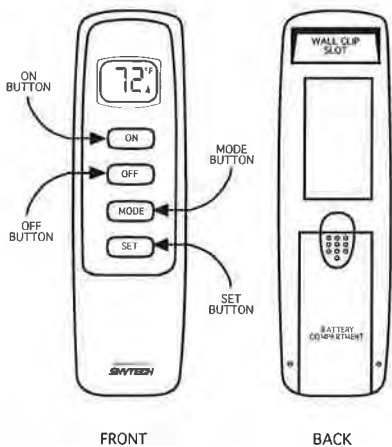

This remote control SYSTEM offers the user a battery-operated remote control to power a latching solenoid such as those used with gas valves used in some heater rated gas logs, gas fireplaces and other gas heating appliances.

The solenoid circuit uses the battery power from the receiver to operate a solenoid. The circuit has reversing polarity software which reverses the positive (+) and negative (-) output of the receiver's battery power to drive a latching solenoid ON/OFF. The SYSTEM is controlled by the remote transmitter.

The transmitter operates on a (2) 1.5V AAA batteries.

It is recommended that ALKALINE batteries always be used for longer battery life and maximum operational performance.

Before using the transmitter, install the (2) AAA transmitter batteries into the battery compartment. (Use caution that batteries are installed in the proper direction)

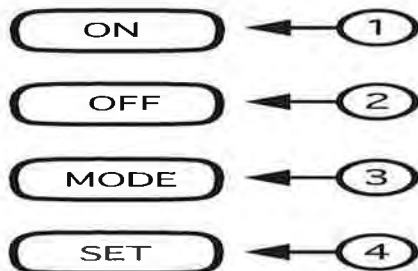

KEY SETTINGS

- ON - Operates unit to on position, Manually operated solenoid ON.
- OFF - Operates unit to off position, Manually operated solenoid OFF.
- MODE - Changes unit from manual mode to thermo mode.
- SET - Sets temperature in thermo mode.

REMOTE CONTROL OPERATION

LCD - Liquid Crystal Display

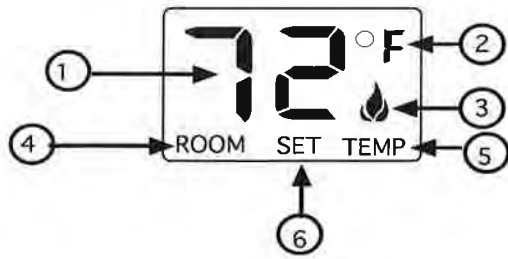

1. **DISPLAY** Indicates CURRENT room temperature .
2. **° F OR ° C** Indicates degrees Fahrenheit or Celsius.
3. **FLAME** Indicates burner/valve in operation.
4. **ROOM** Indicates remote is in THERMO operation.
5. **TEMP** Appears during manual operation.
6. **SET** Appears during time the of setting the desired temperature in the thermo operation.

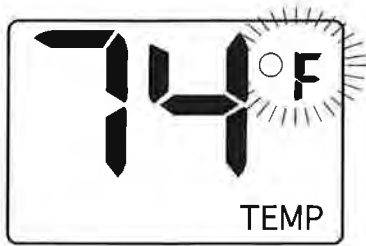

SETTING ° F / ° C SCALE

The factory setting for temperature is ° F. To change this setting to ° C, first

- Press the **ON** key and the **OFF** key on the transmitter at the same time this will change from ° F to ° C. Follow this same procedure to change from ° C back to ° F.

MANUAL FUNCTION

To operate the system in the manual "MODE" do the following

ON OPERATION

Press the **ON** key the appliance flame will come on. During this time the LCD screen will show **ON**, after 3 seconds the LCD screen will default to display room temperature and the word **TEMP** will show. (**Flame icon wil appear on LCD screen in manual on mode**)

OFF OPERATION

Press the **OFF** key the appliance flame will shut off. During this time the LCD screen will show **OF**, after 3 seconds the LCD screen will default to display room temperature and the word **TEMP** will show.



SCREEN WHILE DEPRESSING ON KEY

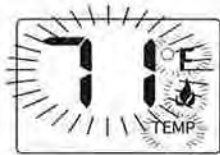

SCREEN AFTER 3 SECOND DEFAULT

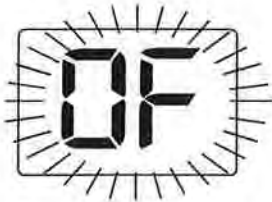

SCREEN WHILE DEPRESSING OFF KEY



SCREEN AFTER 3 SECOND DEFAULT

THERMOSTAT FUNCTION

SETTING DESIRED ROOM TEMPERATURE

This remote control system can be thermostatically controlled when the transmitter is in the THERMO mode (The word **ROOM** must be displayed on the screen). To set the THERMO MODE and DESIRED room temperature,

Press the **MODE** key until the LCD screen shows the word **ROOM**, then the remote is in the thermostatic mode.

Press and hold the **SET** key until the desired set temperature is reached. (By pressing and holding the set key the LCD screen set numbers will increase from 45° to 99° then restart over at 45°) Next release the **SET** key. The LCD screen will display the set temperature



THERMO SET



THERMO MODE

REMOTE CONTROL OPERATION

for 3 seconds and the LCD screen will flash the set temperature for 3 seconds, then the LCD screen will default to display the room temperature.

TO CHANGE THE SET TEMPERATURE

Press and hold the **SET** key until the desired set temperature is reached. (By pressing and holding the set key the LCD screen set numbers will increase from 45° to 99° then restart over at 45°) Next release the **SET** key. The LCD screen will display the set temperature for 3 seconds, then will flash the set temperature for 3 seconds, then the LCD screen will default to display the room temperature.

Press the **MODE** key to disengage the thermo mode. The word **ROOM** on the LCD screen will not show when the thermo is not in operation.

NOTE: The highest SET temperature is 99° Fahrenheit (32° Celsius) and the lowest temperature is 45° Fahrenheit (6° Celsius)

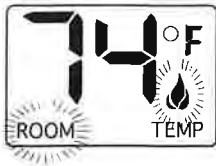

THERMO ON

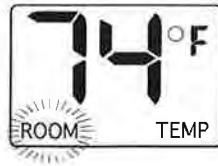

THERMO OFF

OPERATIONAL NOTES:

The Thermo Feature on the transmitter operates the appliance whenever the ROOM TEMPERATURE varies a certain number of degrees from the SET TEMPERATURE. This variation is called the "SWING" or TEMPERATURE DIFFERENTIAL. The normal operating cycle of an appliance may be 2-4 times per hour depending on how well the room or home is insulated from the cold or drafts. The factory setting for the "swing number" is 2. This represents a temperature variation of +/- 2° F (1° C) between SET temperature and ROOM temperature, which determines when the fireplace will be activated.

The transmitter has ON and OFF manual functions that are activated by pressing either button on the face of the transmitter. When a button on the transmitter is pressed the word ON or OF will appear on the LCD screen to show while the signal is being sent. Upon initial use, there may be a delay of three seconds before the remote receiver will respond to the transmitter. This is part of the system's design.

POWER SETTING – CON 1001 TH

The electronics in the remote control system have the capability of "powering" two different types of DC-powered components. If any operational problems are noted, contact Customer Service.

The RECEIVER comes from the factory programmed to provide pulse DC voltage (5.5 VDC to 6.3 VDC) to a latching solenoid.

REMOTE RECEIVER

IMPORTANT

THE REMOTE RECEIVER SHOULD BE POSITIONED WHERE AMBIENT TEMPERATURES DO NOT EXCEED 130° F.

The remote receiver (right) operates on (4) 1.5V AA-size batteries. It is recommended that ALKALINE batteries be used for longer battery life and maximum microprocessor performance. **IMPORTANT:** New or fully charged batteries are essential to proper operation of the remote receiver as a latching solenoid power consumption is substantially higher than standard remote control systems.

NOTE: The remote receiver will only respond to the transmitter when the 3-position slide button on the remote receiver is in the REMOTE position. The remote receiver houses the microprocessor that responds to commands from the transmitter to control system operation.

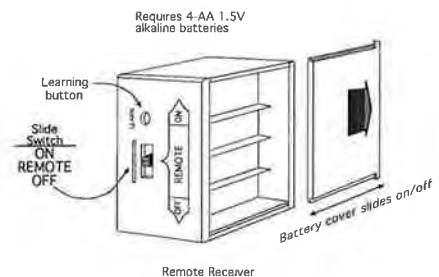

REMOTE CONTROL OPERATION

FUNCTIONS:

- With the slide switch in the REMOTE position, the system will only operate if the remote receiver receives commands from the transmitter.
- Upon initial use or after an extended period of no use, the ON button may have to be pressed for up to three seconds before activating servo motor. If the system does not respond to the transmitter on initial use, see LEARNING TRANSMITTER TO RECEIVER.
- With the slide switch in the ON position you can manually turn ON the system.
- With the slide in the OFF position, the system is OFF.
- It is suggested that the slide switch be placed in the OFF position if you will be away from your home for an extended period of time.
- Placing the slide switch in the OFF position also functions as a safety "lock out" by both turning the system OFF and rendering the transmitter inoperative.

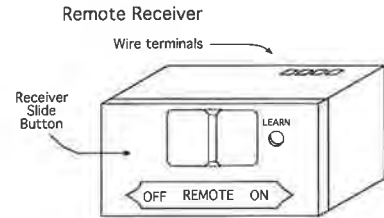

INSTALLATION INSTRUCTIONS

WARNING

DO NOT CONNECT REMOTE RECEIVER DIRECTLY TO 110-120VAC POWER. THIS WILL BURN OUT THE RECEIVER. FOLLOW INSTRUCTIONS FROM MANUFACTURER OF GAS VALVE FOR CORRECT WIRING PROCEDURES. IMPROPER INSTALLATION OF ELECTRIC COMPONENTS CAN CAUSE DAMAGE TO GAS VALVE AND REMOTE RECEIVER.

INSTALLATION

The remote receiver can be mounted on or near the fireplace hearth. PROTECTION FROM EXTREME HEAT IS VERY IMPORTANT. Like any piece of electronic equipment, the remote receiver should be kept away from temperatures exceeding 130° F inside the receiver case. Battery life is also significantly shortened if batteries are exposed to high temperatures.

HEARTH MOUNT

The remote receiver can be placed on the fireplace hearth or under the fireplace, behind the control access panel. Position where the ambient temperature inside the receiver case does not exceed 130° F. **NOTE:** Black Button is used on Hearth Mount Applications.

WIRING INSTRUCTIONS

Make sure the remote receiver switch is in the OFF position. For best results it is recommended that 18 gauge stranded wires should be used to make connections and no longer than 20-feet.

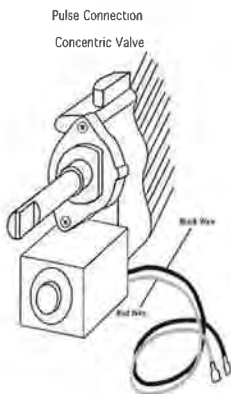

This CON1001 TH remote receiver is to be connected to a manual valve with a latching ON/OFF solenoid.

Connect two 18 gauge stranded or solid wires from the remote receiver terminals to the latching solenoid. (See figure to the right)

IMPORTANT NOTE: Operation of this control is dependent on which wire is attached to which terminal. If operation of control does not correspond to operating buttons on transmitter, reverse wire installation at the receiver or at the control.

NOTE: Up to 6.3 VDC of power is provided at the receiver terminal.

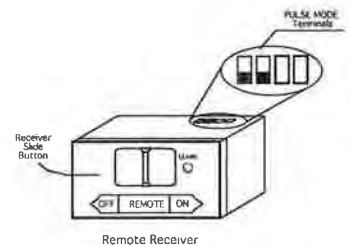
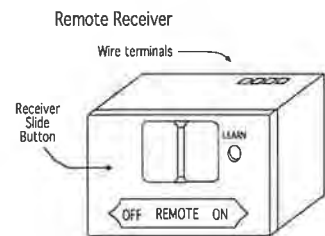

REMOTE CONTROL OPERATION

GENERAL INFORMATION

COMMUNICATION – SAFETY – TRANSMITTER – (C/S – TX)

This remote control has a COMMUNICATION –SAFETY function built into its software. It provides an extra margin of safety when the TRANSMITTER is out of the normal 20-foot operating range of the receiver.

The COMMUNICATION – SAFETY feature operates in the following manner, in all OPERATING MODES – ON/ ON THERMO.

At all times and in all OPERATING MODES, the transmitter sends an RF signal every fifteen (15) minutes, to the receiver, indicating that the transmitter is within the normal operating range of 20-feet. Should the receiver NOT receive a transmitter signal every 15 minutes, the IC software, in the RECEIVER, will begin a 2-HOUR (120-minute) countdown timing function. If during this 2-hour period, the receiver does not receive a signal from the transmitter, the receiver will shut down the appliance being controlled by the receiver. The RECEIVER will then emit a series of rapid "beeps" for a period of 10 seconds. Then after 10 seconds of rapid beeping, the RECEIVER will continue to emit a single "beep" every 4 seconds until a transmitter ON or MODE Button is pressed to reset the receiver. The intermittent 4-second beeping will go on for as long as the receiver's batteries last which could be in excess of one year.

To "reset" the RECEIVER and operate the appliance, you must press the ON or MODE button on the transmitter. By turning the system to ON, the COMMUNICATION -SAFETY operation is overridden and the system will return to normal operation depending on the MODE selected at the transmitter. The COMMUNICATION – SAFETY feature will reactivate should the transmitter be taken out of the normal operating range or should the transmitter's batteries fail or be removed.

CP (CHILDPROOF) FEATURE

This remote control includes a CHILDPROOF "LOCK-OUT" feature that allows the user to "LOCK-OUT" operation of the appliance, from the TRANSMITTER.

SETTING "LOCK-OUT" –(CP)

- To activate the "LOCK-OUT" feature, press and hold the ON button and the MODE button at the same time for 5 seconds. The letters CP will appear in the TEMP frame on the LCD screen.
- To disengage the "LOCK-OUT", press and hold the ON button and the MODE button at the same time for 5 seconds and the letters CP will disappear from the LCD screen and the transmitter will return to its normal operating condition.
- To verify that transmitter is in the CP lock-out mode press any key and the LCD screen will show "CP"

NOTE: If the appliance is already operating in the ON or THERMO MODES, engaging the "LOCK-OUT" will not cancel the operating MODE. Engaging the "LOCK-OUT" prevents only the manual operation of the TRANSMITTER. If in the auto modes, the THERMO operation will continue to operate normally. To totally "LOCK-OUT" the operation of the TRANSMITTER'S operating signals; the transmitter's MODE must be set to OFF.

LEARNING TRANSMITTER TO RECEIVER

Each transmitter uses a unique security code. It will be necessary to press the LEARN button on the receiver to accept the transmitter security code upon initial use, if batteries are replaced, or if a replacement transmitter is purchased from your dealer or the factory. In order for the receiver to accept the transmitter security code, be sure the slide button on the receiver is in the REMOTE position; the receiver will not LEARN if the slide switch is in the ON or OFF position. The LEARN button is located on the front face of the receiver; inside the small hole labeled LEARN. Using a small screwdriver or end of a paperclip gently press and release the black LEARN button inside the hole. When you release the LEARN button the receiver will emit an audible "beep". After the receiver emits the beep press the transmitter ANY button and release. The receiver will emit several beeps indicating that the transmitter's code has been accepted into the receiver.

The microprocessor that controls the security code matching procedure is controlled by a timing function. If you are unsuccessful in matching the security code on the first attempt, wait 1 - 2 minutes before trying again--this delay allows the microprocessor to reset its timer circuitry--and try up to two or three more times.

REMOTE CONTROL OPERATION

TRANSMITTER WALL CLIP

The transmitter can be hung on a wall using the clip provided. If the clip is installed on a solid wood wall, drill 1/8" pilot holes and install with the screws provided. If it is installed on a plaster/wallboard wall, first drill two 1/4" holes into the wall. Then use a hammer to tap in the two plastic wall anchors flush with the wall; then install the screws provided.

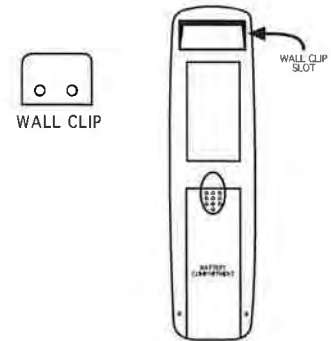

BATTERY LIFE

Life expectancy of the alkaline batteries in the CON1001-TH can be up to 12 months depending on use of the solenoid function. Replace all batteries annually. When the transmitter no longer operates the remote receiver from a distance it did previously (i.e., the transmitter's range has decreased) or the remote receiver does not function at all, the batteries should be checked. It is important that the remote receiver batteries are fully charged, providing combined output voltage of at least 5.5volts. The transmitter should operate with as little as 2.5 volts battery power.

TROUBLE SHOOTING

If you encounter problems with your fireplace system, the problem may be the fireplace itself or it could be with the CON1001-TH remote system. Review the fireplace manufacturer's operation manual to make sure all connections are properly made. Then check the operation of the remote in the following manner:

- Make sure the batteries are correctly installed in the RECEIVER. One reversed battery will keep receiver from operating properly.
- Check battery in TRANSMITTER to ensure contacts are touching (+) and (-) ends of battery. Bend metal contacts in for tighter fit.
- Be sure RECEIVER and TRANSMITTER is within 20 to 25-foot operating range.
- Clear Codes: Memory in the receiver might be full if the learn button is pressed too many times. If this happens it will not allow any more codes to be learned and no audible beep will be heard. To clear memory, place the receiver slide switch into the REMOTE position. Press the learn button and release after 10 seconds. You should hear three (3) long audible beeps indicating all codes have cleared. You can now "learn" the transmitter to the receiver as described in the General Information Section.
- Keep RECEIVER from temperatures exceeding 130° F. Battery life shortened when ambient temperatures are above 115° F.
- If RECEIVER is installed in tightly enclosed metal surround, the operating distance will be shortened.

SPECIFICATIONS

BATTERIES: Transmitter (2) 1.5 volt AAA batteries
Remote Receiver 6V - 4 ea. AA 1.5 Alkaline

Operating Frequency: 303.8 MHZ

FCC ID No.'s: transmitter - K9LSP1001TH; receiver - K9L330IRX

Canadian IC ID No.'s: transmitter - 2439A-SP1001TH; receiver - 2439A-3301RX

FCC REQUIREMENTS

NOTE: THE MANUFACTURER IS NOT RESPONSIBLE FOR ANY RADIO OR TV INTERFERENCE CAUSED BY UNAUTHORIZED MODIFICATIONS TO THIS EQUIPMENT. SUCH MODIFICATIONS COULD VOID THE USER'S AUTHORITY TO OPERATE THE EQUIPMENT.

OPERATION

INSPECTING BURNERS

Check pilot flame pattern and burner flame patterns often.

PILOT FLAME PATTERN

Figure 20 shows a correct pilot flame pattern. Figure 21 shows an incorrect pilot flame pattern. The incorrect pilot flame is not touching the thermocouple. This will cause the thermocouple to cool. When the thermocouple cools, the fireplace will shut down.

If pilot flame pattern is incorrect, as shown in Figure 21.

- turn fireplace off (see To Turn Off Gas to Appliance, page 24).
- see Troubleshooting, page 34.

Note: The pilot flame on natural gas units will have a slight curve, but flame should be blue and have no yellow or orange color.

Fig. 20 - Correct Pilot Flame Pattern

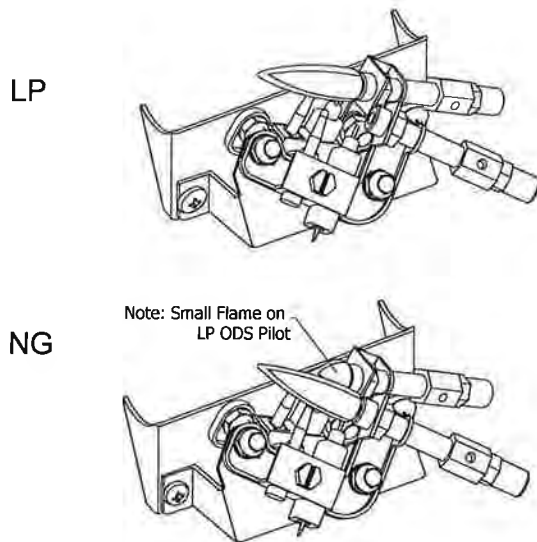
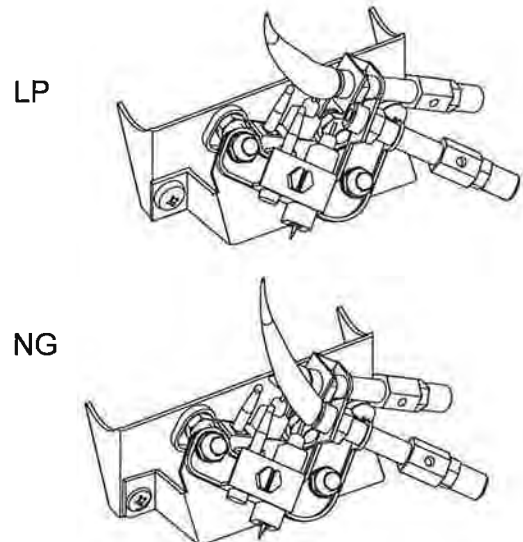

Fig. 21 - Incorrect Pilot Flame Pattern



⚠ WARNING: If yellow tipping occurs, your heater could produce increased levels of carbon monoxide. If burner flame pattern shows yellow tipping, follow instructions at bottom of this page.

⚠ WARNING: Do not allow fans to blow directly into the fireplace. Avoid any drafts that alter burner flame patterns.

⚠ WARNING: Do not use a blower insert, heat exchanger insert or other accessory not approved for use with this heater.

Notice: Do not mistake orange flames with yellow tipping. Dirt or other fine particles enter the heater and burn causing brief patches of orange flame.

CARE AND MAINTENANCE

BURNER FLAME PATTERN

Figure 22 shows a correct burner flame pattern. Figure 23 shows an incorrect burner flame pattern. The incorrect burner flame pattern shows sporadic, irregular flame tipping. The flame should not be dark or have an orange/reddish tinge.

Note: When using the fireplace the first time, the flame will be orange for approximately one hour until the log cures.

If burner flame pattern is incorrect, as shown in Figure 23

- turn fireplace off (see To Turn Off Gas to Appliance, page 34).
- see Troubleshooting, page 34.



Fig. 22 - Correct Burner Flame Pattern



Fig. 23 - Incorrect Burner Flame Pattern

⚠ WARNING: Turn off heater and let cool before servicing.

⚠ CAUTION: You must keep control areas, burner, and circulating air passageways of heater clean. Inspect these areas of heater before each use. Have heater inspected yearly by a qualified service person. Heater may need more frequent cleaning due to excessive lint from carpeting, bedding material, pet hair, etc.

⚠ WARNING: Failure to keep the primary air opening(s) of the burner(s) clean may result in sooting and property damage.

BURNER ORIFICE HOLDER AND PILOT AIR INLET HOLE

The primary air inlet holes allow the proper amount of air to mix with the gas. This provides a clean burning flame. Keep these holes clear of dust, dirt, lint and pet hair. Clean these air inlet holes prior to each heating season. Blocked air holes will create soot. We recommend that you clean the unit every three months during operation and have fireplace inspected yearly by a qualified service person.

We also recommend that you keep the burner tube and pilot assembly clean and free of dust and dirt. To clean these parts we recommend using compressed air no greater than 30 PSI. Your local computer store, hardware store or home center may carry compressed air in a can. If using compressed air in a can, please follow the directions on the can. If you don't follow directions on the can, you could damage the pilot assembly.

CARE AND MAINTENANCE

1. Shut off unit including pilot. Allow unit to cool for at least 30 minutes.
2. Inspect burner, pilot and primary air inlet holes on orifice holder for dust and dirt (See Fig. 24).
3. Blow air through the ports/slots and holes in the burner.
4. Check the orifice holder located at the end of the burner tube again. Remove any large particles of dust, dirt, lint or pet hair with a soft cloth or vacuum cleaner nozzle.
5. Blow air into the primary air holes on the orifice holder.
6. In case any large clumps of dust have now been pushed into the burner repeat steps 3 and 4. Clean the pilot assembly also. A yellow tip on the pilot flame indicates dust and dirt in the pilot assembly. There is a small pilot air inlet hole about 2" from where the pilot flame comes out of the pilot assembly (see Figures 34 or 35 depending on model). With the unit off, lightly blow air through the air inlet hole. You may blow through a drinking straw if compressed air is not available.

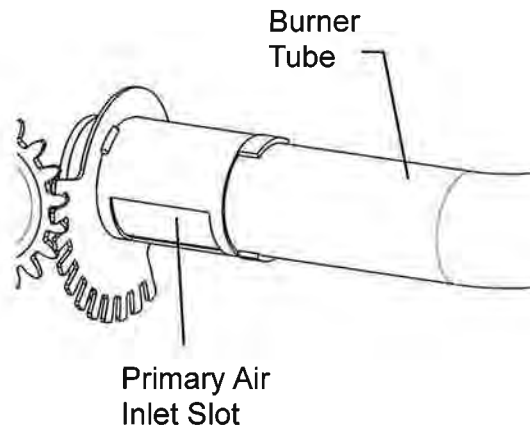

Fig. 24 - Primary Air Inlet Slot on Burner Tube

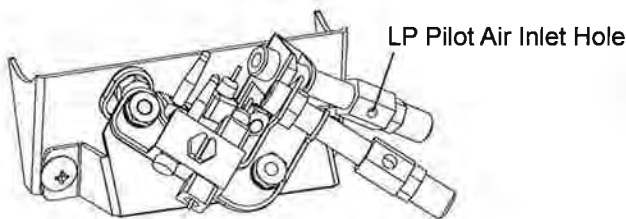

Fig. 25 - Pilot Inlet Air Hole (Propane/LP Gas)

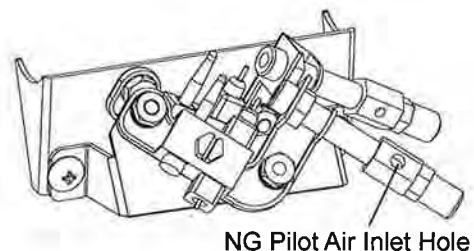

Fig. 26 - Pilot Inlet Air Hole (Natural Gas)

LOG SET

- If you remove the log set for cleaning, refer to pages 20 & 21, for placement instructions.
- Replace log set if broken or chipped (dime sized or larger).

CABINET

Air Passageways

Use a vacuum cleaner or pressurized air to clean.

Exterior

Use a soft cloth dampened with a mild soap and water mixture. Wipe the cabinet to remove dust.

TROUBLESHOOTING

⚠ WARNING: If you smell gas:

- Shut off gas supply.
- Do not try to light any appliance.
- Do not touch any electrical switch; do not use any phone in your building.
- Immediately call your gas supplier from a neighbor's phone. Follow the gas supplier's instructions.
- If you cannot reach your gas supplier, call the fire department.

IMPORTANT: Operating heater where impurities in air exist may create odors. Cleaning supplies, paint, paint remover, cigarette smoke, cements and glues, new carpet or textiles, etc., create fumes. These fumes may mix with combustion air and create odors.

⚠ WARNING: Make sure that power is turned off before proceeding.

⚠ WARNING: Turn off and let cool before servicing. Only a qualified service person should service and repair heater.

⚠ CAUTION: Never use a wire, needle, or similar object to clean ODS/pilot. This can damage ODS/ pilot unit.

SERVICE HINTS

When Gas Pressure Is Too Low

- pilot will not stay lit
- burners will have delayed ignition
- fireplace will not produce specified heat
- for propane/LP units, propane/LP gas supply may be low

You may feel your gas pressure is too low. If so, contact your local natural or propane/LP gas supplier.

PROBLEM	POSSIBLE CAUSE	CORRECTIVE ACTION
When ignitor button is pressed in, there is no spark at ODS/ pilot.	<ol style="list-style-type: none"> 1. Ignitor electrode is positioned wrong. 2. Ignitor electrode is broken. 3. Ignitor electrode is not connected to ignitor cable. 4. Ignitor cable is pinched or wet. 5. Damaged ignitor cable. 6. Bad piezo ignitor. 7. Bad Battery. 	<ol style="list-style-type: none"> 1. Replace electrode. 2. Replace electrode. 3. Replace ignitor cable 4. Free ignitor cable if pinched by any metal or tubing. Keep ignitor cable dry. 5. Replace ignitor cable. 6. Replace piezo ignitor. 7. Check Battery and replace if needed.
When ignitor button is pressed in, there is a spark at ODS/ pilot but no ignition.	<ol style="list-style-type: none"> 1. Gas supply is turned off or equipment shutoff valve is closed. 2. Control knob not fully pressed in while pressing ignitor button. 3. Air in gas lines when installed. 4. ODS / pilot is clogged. 5. Gas regulator setting is not correct. 6. Control knob not in PILOT position. 7. Depleted gas supply (propane). 	<ol style="list-style-type: none"> 1. Turn on gas supply or open equipment shutoff valve. 2. Fully press in control knob while pressing ignitor button. 3. Continue holding down control knob. Repeat igniting operation until air is removed. 4. Clean ODS/pilot (see Care and Maintenance, page 32) or replace ODS/pilot assembly. 5. Replace gas regulator. 6. Turn control knob to PILOT position. 7. Contact local propane/LP gas company.

TROUBLESHOOTING

PROBLEM	POSSIBLE CAUSE	CORRECTIVE ACTION
ODS/pilot lights but flame goes out when control knob is released.	<ol style="list-style-type: none"> 1. Control knob is not fully pressed in. 2. Control knob is not pressed in long enough. 3. Equipment shutoff valve is not fully open. 4. Thermocouple connection is loose. 5. Thermocouple damaged. 6. Control valve damaged. 	<ol style="list-style-type: none"> 1. Press in control knob fully. 2. After ODS/pilot lights, keep control knob pressed in 30 seconds. 3. Fully open equipment shutoff valve. 4. Hand tighten until snug, and then tighten ¼ turn more. 5. Replace thermocouple. 6. Contact customer service.
Burner(s) does not light after ODS/pilot is lit.	<ol style="list-style-type: none"> 1. Burner orifice is clogged. 2. Burner orifice diameter is too small. 3. Inlet gas pressure is too low. 	<ol style="list-style-type: none"> 1. Clean burner orifice (see Care and Maintenance, page 32) or contact customer service. 2. Contact customer service. 3. Contact your gas supplier.
Delayed ignition of burner(s).	<ol style="list-style-type: none"> 1. Manifold pressure is too low. 2. Burner orifice is clogged. 	<ol style="list-style-type: none"> 1. Contact your gas supplier. 2. Clean burner (see Care and Maintenance, page 32) or contact customer service.
Burner backfiring during combustion.	<ol style="list-style-type: none"> 1. Burner orifice is clogged or damaged. 2. Burner is damaged. 3. Gas regulator is damaged. 	<ol style="list-style-type: none"> 1. Clean burner orifice (see Care and Maintenance, page 32) or contact customer service. 2. Contact dealer or customer service. 3. Replace gas regulator.
High yellow flame during burner combustion	<ol style="list-style-type: none"> 1. Not enough air. 2. Gas regulator is defective. 3. Inlet gas pressure is too low. 	<ol style="list-style-type: none"> 1. Check burner for dirt and debris. If found, clean burner (see Care and Maintenance, page 32). 2. Replace gas regulator. 3. Contact your gas supplier.
Gas odor during combustion.	<ol style="list-style-type: none"> 1. Foreign matter between control valve and burner. 2. Gas leak. (See Warning Statement at top of page 34). 	<ol style="list-style-type: none"> 1. Take apart gas tubing and remove foreign matter. 2. Locate and correct all leaks (see "Checking Gas Connections," page 22).
Heater produces a clicking/ticking noise just after burner is lit or shut off.	<ol style="list-style-type: none"> 1. Metal is expanding while heating or contracting while cooling. 	<ol style="list-style-type: none"> 1. This is common with most heaters. If noise is excessive, contact qualified service technician.

TROUBLESHOOTING

PROBLEM	POSSIBLE CAUSE	CORRECTIVE ACTION
White powder residue forming within burner box or on adjacent walls or furniture.	1. When heated, the vapors from furniture polish, wax, carpet cleaners, etc., turn into white powder residue.	1. Turn heater off when using furniture polish, wax, carpet cleaner or similar products.
Heater produces unwanted odors.	1. Heater is burning vapors from paint, hair spray, glues, etc. See IMPORTANT statement, page 34. 2. Gas leak. See Warning Statement, page 34. 3. Low fuel supply.	1. Ventilate room. Stop using odor causing products while heater is running. 2. Locate and correct all leaks (see "Checking Gas Connections," page 22). 3. Refill supply tank (Propane /LP models).
Heater shuts off in use (ODS operates).	1. Not enough fresh air is available. 2. Low line pressure. 3. ODS/pilot is partially clogged.	1. Open window and/or door for ventilation. 2. Contact local gas supplier. 3. Clean ODS/pilot (see Care and Maintenance, page 32).
Gas odor exists even when control knob is in OFF position.	1. Gas leak. See Warning Statement at top of page 34. 2. Control valve is defective.	1. Locate and correct all leaks (see "Checking Gas Connections", page 22). 2. Contact customer service.
Moisture/condensation noticed on windows.	1. Not enough combustion/ventilation air.	1. Refer to "Air for Combustion and Ventilation" requirements, page 9-11.
Slight smoke or odor during initial operation	1. Residues from manufacturing process.	1. Problem will stop after a few hours of operation.
Heater produces a whistling noise when burner is lit.	1. Turning control knob to high (5) position when burner is cold. 2. Air in gas line. 3. Air passageways on heater are blocked. 4. Dirty or partially clogged burner orifice.	1. Turn control knob to low (1) position and let warm up for a minute. 2. Operate burner until air is removed from line. Have gas line checked by local propane/LP gas company. 3. Observe minimum installation clearances (Fig. 6, page 12) 4. Clean burner (see Care and Maintenance, page 32) or contact customer service.

REPLACEMENT PARTS

For replacement parts, call our Technical service department at 1-814-643-1775, 8:30 a.m. – 4:30 p.m., CST, Monday – Friday.

FIREBOX MODELS GFD 2042 / 2670 / 3280R / 3290R

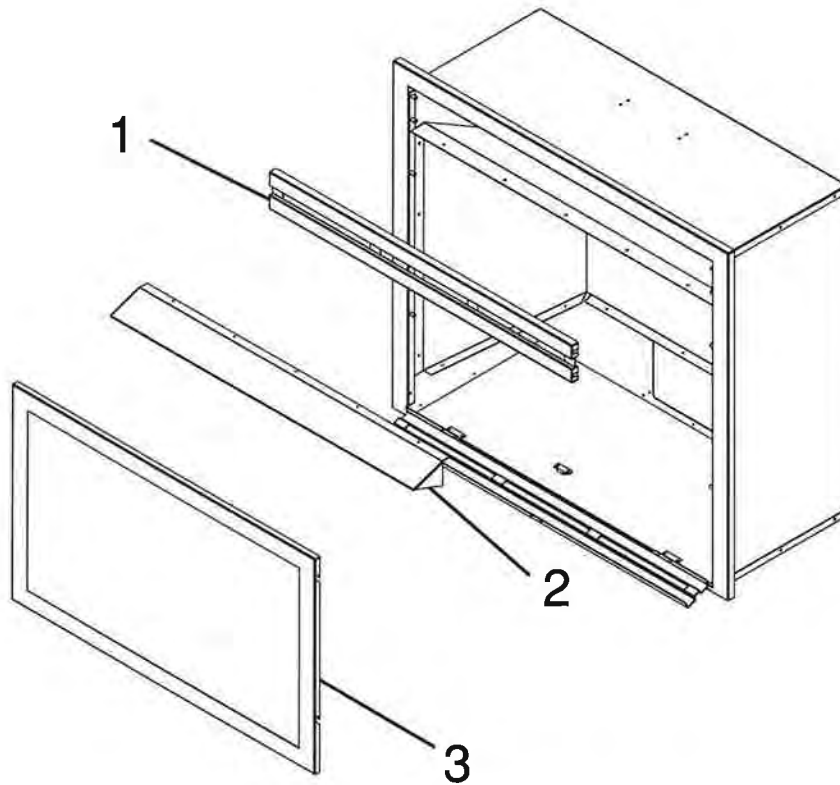

ITEM No.	DESCRIPTION	QTY	PART NUMBER		
			GFD2042 Series	GFD2670 Series	GFD3280R GFD3290R Series
1	Top Grille	1	700-S1014B	700-M1014B	700-L1014B
2	Hood	1	700-S1012B	700-M1012B	700-L1012B
3	Window Frame Assembly	1	700-AS1015	700-AM1015	700-AL1015

REPLACEMENT PARTS LIST

For replacement parts, call our Technical service department at 1-814-643-1775, 8:30 a.m. – 4:30 p.m., CST, Monday – Friday.

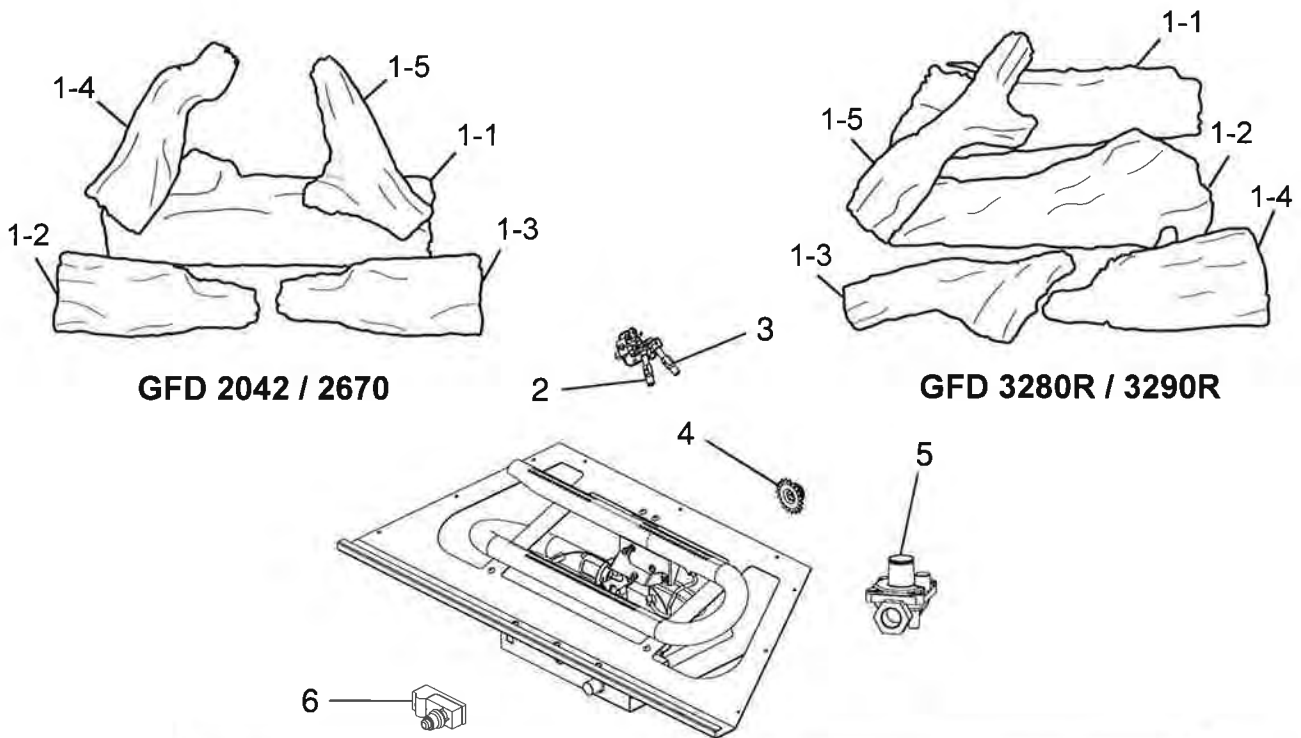

GFD 2042 / 2670

GFD 3280R / 3290R

ITEM No.	DESCRIPTION	QTY	PART NUMBER		
			GFD2042 Series	GFD2670 Series	GFD3280R GFD3290R Series
1	Log Set (complete)	1	700-S1018	700-M1018	700-L1018
1 - 1	Log 1	1	700-S1018-01	700-M1018-01	700-L1018-01
1 - 2	Log 2	1	700-S1018-02	700-M1018-02	700-L1018-02
1 - 3	Log 3	1	700-S1018-03	700-M1018-03	700-L1018-03
1 - 4	Log 4	1	700-S1018-04	700-M1018-04	700-L1018-04
1 - 5	Log 5	1	700-S1018-05	700-M1018-05	700-L1018-05
2	ODS Pilot - LP	1	8085747b	8085747b	8085747b
3	ODS Pilot - NG	1	80857462b	80857462b	80857462b
4	Selector Knob	1	EXP-4022	EXP-4022	EXP-4022
5	Regulator	1	GRH60C-4.5-12	GRH60C-4.5-10	GRH60-4.0-10
6	Ignitor Module	1	301-01015-06	301-01015-06	301-01015-06
7	Remote Receiver	1	-	-	80-05-102
8	Thermostat Remote	1	-	-	80-05-101

ACCESSORIES

NOTICE: All accessories may not be available for all fireplace models.

THERMOSTAT-CONTROLLED BLOWER KIT - 20-6140 For all models. Provides better heat distribution. Makes fireplace more efficient. Automatically turns off and on as needed.

