

# CLEANVIEW<sup>®</sup> Vacuum

---

USER GUIDE  
1831, 1834 SERIES



More of a video person? Look for this icon and go online for an instructional how-to video at

[www.BISELL.com](http://www.BISELL.com)

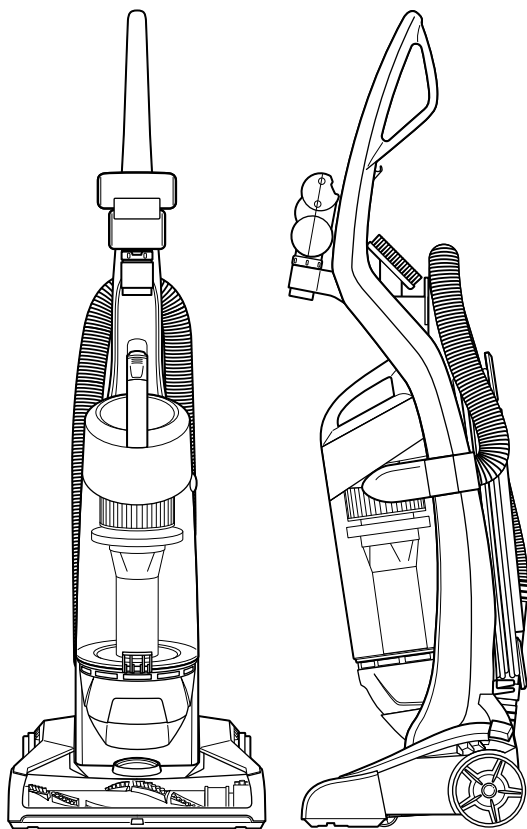

# IMPORTANT SAFETY INSTRUCTIONS

## READ ALL INSTRUCTIONS BEFORE USING YOUR UPRIGHT VACUUM.

Always connect to a polarized outlet (one slot is wider than the other). Unplug from outlet when not in use and before conducting maintenance. When using an electrical appliance, basic precautions should be observed, including the following:

### **WARNING**

#### **TO REDUCE THE RISK OF FIRE, ELECTRIC SHOCK, OR INJURY:**

- » Do not leave vacuum cleaner when it is plugged in. Unplug from outlet when not in use and before servicing.
- » Do not use outdoors or on wet surfaces.
- » Do not allow to be used as a toy. Close attention is necessary when used by or near children.
- » Do not use for any purpose other than described in this User's Guide. Use only manufacturer's recommended attachments.
- » Do not use with damaged cord or plug. If appliance is not working as it should, has been dropped, damaged, left outdoors, or dropped into water, have it repaired at an authorized service center.
- » Do not pull or carry by cord, use cord as a handle, close a door on cord, or pull cord around sharp edges or corners. Do not run appliance over cord. Keep cord away from heated surfaces.
- » Do not unplug by pulling on cord. To unplug, grasp the plug, not the cord.
- » Do not handle plug or vacuum cleaner with wet hands.
- » Do not put any object into openings. Do not use with any opening blocked; keep openings free of dust, lint, hair, and anything that may reduce air flow.
- » Keep hair, loose clothing, fingers, and all parts of body away from openings and moving parts.
- » Turn off all controls before plugging or unplugging vacuum cleaner.
- » Use extra care when cleaning on stairs.
- » Do not use to pick up flammable or combustible materials (lighter fluid, gasoline, kerosene, etc.) or use in areas where they may be present.
- » Do not use vacuum cleaner in an enclosed space filled with vapors given off by oil base paint, paint thinner, some moth proofing substances, flammable dust, or other explosive or toxic vapors.
- » Do not use to pick up toxic material (chlorine bleach, ammonia, drain cleaner, etc.).
- » Do not pick up anything that is burning or smoking, such as cigarettes, matches, or hot ashes.
- » Do not use without filters in place.
- » Do not pick up hard or sharp objects such as glass, nails, screws, coins, etc.
- » Use only on dry, indoor surfaces.
- » Keep appliance on a level surface.
- » Do not carry the vacuum cleaner while it is running.
- » Unplug before connecting or disconnecting the TurboBrush® Tool.

## SAVE THESE INSTRUCTIONS

This model is for household use only.

### **WARNING**

- » Before using your vacuum, make sure the dirt container is in locked position and that all filters, both pre- and post-filters are in place. **DO NOT** operate your vacuum without these filters.
- » Plastic film can be dangerous. To avoid danger of suffocation, keep away from children.
- » Do not plug in your vacuum UNTIL you are familiar with all instructions and operating procedures.
- » To reduce the risk of electrical shock, turn power switch off and disconnect polarized plug from electrical outlet BEFORE performing maintenance or troubleshooting checks.

## THIS APPLIANCE HAS A POLARIZED PLUG

To reduce the risk of electric shock, this appliance has a polarized plug (one blade is wider than the other). This plug will fit in a polarized outlet only one way. If the plug does not fit fully in the outlet, reverse the plug. If it still does not fit, contact a qualified electrician to install a proper outlet. Do not change the plug in any way.

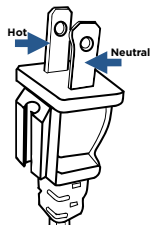

# Thanks for buying a BISSELL vacuum!

We love to clean and we're excited to share one of our innovative products with you. This guide has important instructions on how your new vacuum works, including using (page 6), maintaining (pages 7-9), and if there is a problem, troubleshooting (page 10).

In just a few simple assembly steps, you'll be ready to vacuum. Flip to page 5 and let's get started!

## What's In The Box?

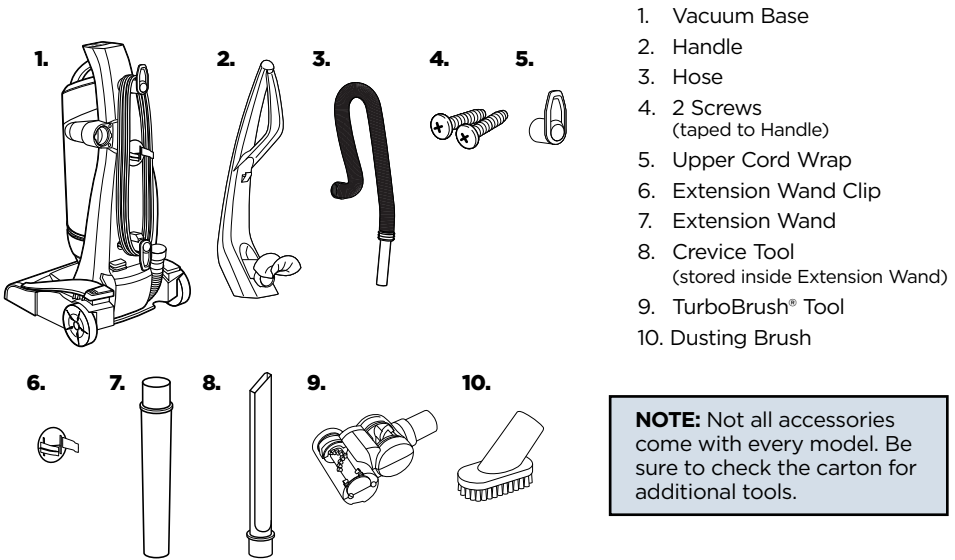

Safety Instructions.....	2	Warranty.....	11
Product View.....	4	Service.....	11
Assembly.....	5	Contact Information.....	12
Operations.....	6	Product Registration.....	12
Maintenance & Care.....	7-9	Parts & Supplies.....	12
Troubleshooting.....	10		

# Product View

## **WARNING**

Do not plug in your vacuum until you are familiar with all instructions and operating procedures.

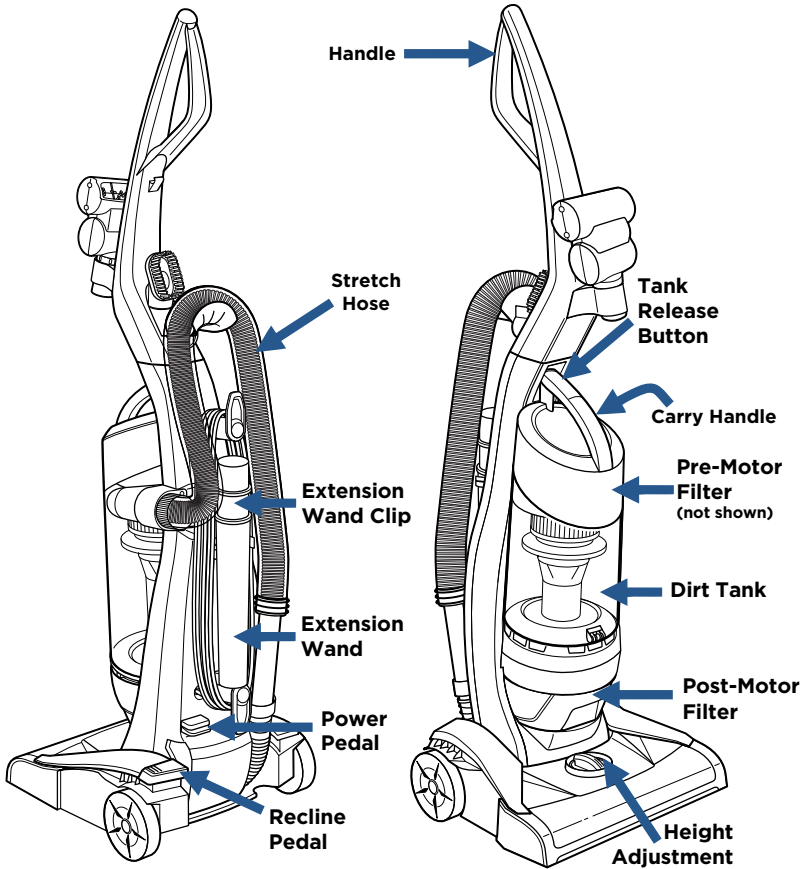

**NOTE:** The Crevice Tool is stored inside the Extension Wand.

# Assembly

The only tool you will need to assemble your vacuum is a Phillips screwdriver.

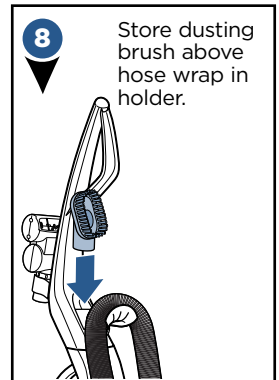
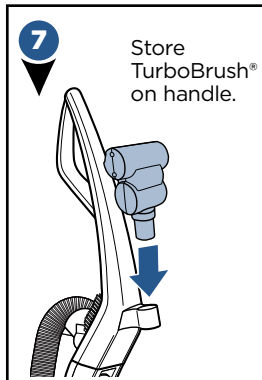
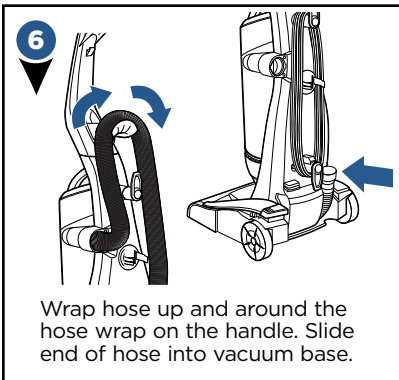
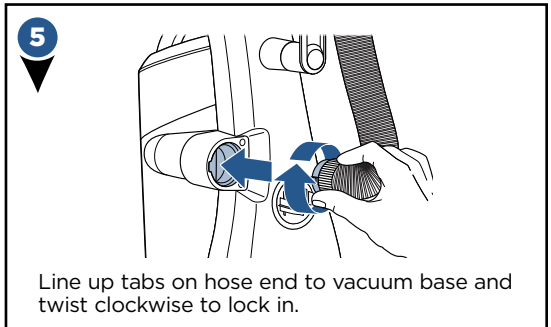
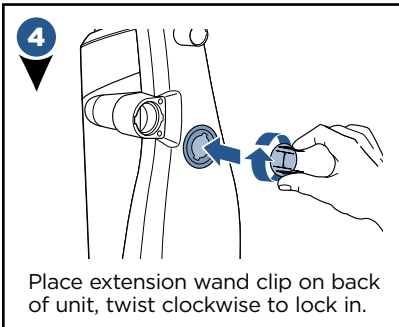
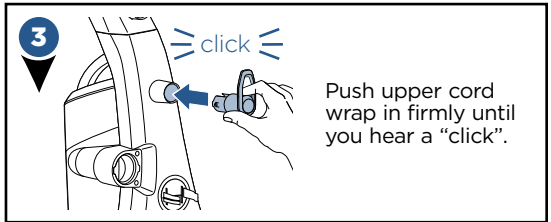
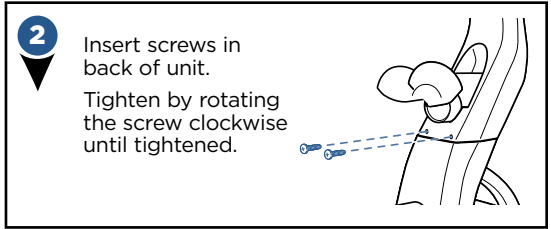
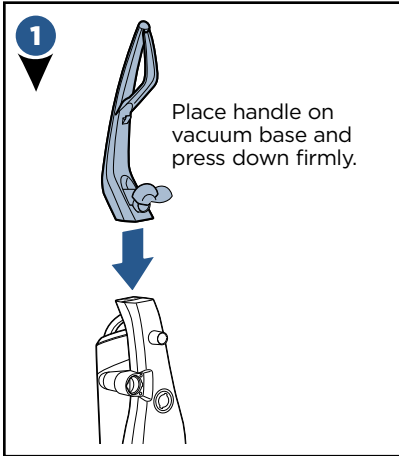
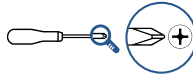

**NOTE:** The powerfoot will not suction properly unless the hose is firmly attached.

# Operations: Power On & Settings

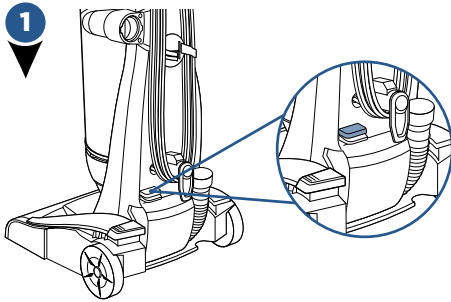

Push the Red Power Switch Pedal ① once to turn the unit ON and once again to turn the unit OFF.

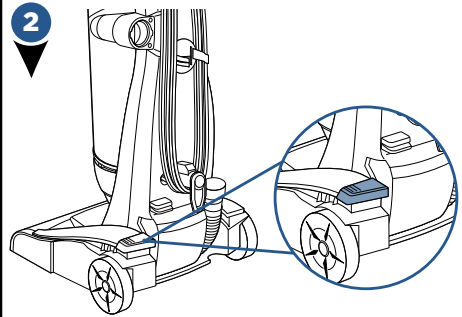

Press the recline pedal and pull handle back towards you.

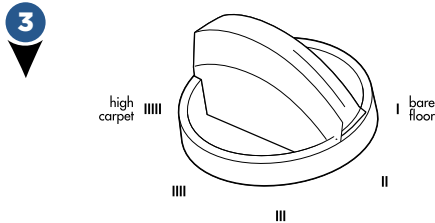

Turn the dial on the foot of the vacuum to the desired setting. If the dial is difficult to turn, tilt the vacuum back slightly to take the weight off the foot while turning.

- Lowest setting** - For low pile carpet or bare floors. To pick up debris, it may be necessary to move up one setting.
- Medium setting** - For medium pile carpet.
- Highest setting** - For high pile and most shag carpet.

**TIP:** For optimal carpet cleaning performance, adjust to the lowest practical setting. If your vacuum is difficult to push, adjust to the next higher setting.

## WARNING

To reduce the risk of injury from moving parts while the vacuum is turned on, always move the vacuum via the rolling wheels by using the upper handle at the back of the vacuum. Do not carry the vacuum while it is running. Always place vacuum on floor with handle in upright position when using tools.

**NOTE:** The rotating floor brush continues to rotate while tools are in use. Never place your fingers under the vacuum when it is running. Never place powerfoot on furniture or uneven surfaces. Do not place vacuum close enough to objects to pull them into rotating brush.

**NOTE:** Certain carpets and low humidity conditions may generate small static discharges. Static discharges are entirely harmless and are not associated in any way with the main power supply.

# Maintenance: Clean Dirt Tank



## ⚠️ WARNING

To reduce the risk of electric shock, turn power switch off and disconnect polarized plug from electrical outlet before performing maintenance or troubleshooting checks.

1

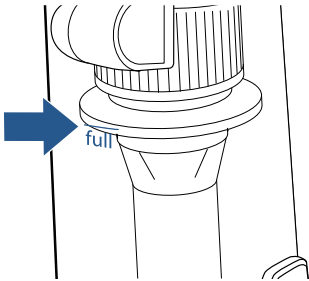

Empty once tank is full.

2



Press tank release button and remove dirt tank.

3

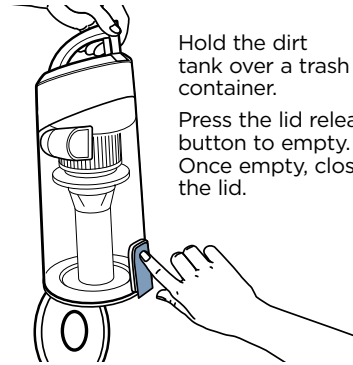

Hold the dirt tank over a trash container.  
Press the lid release button to empty. Once empty, close the lid.

4

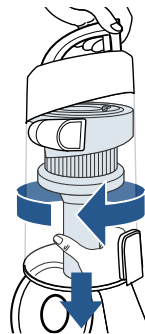

Twist cyclone counter clockwise and pull down to remove from tank.

5

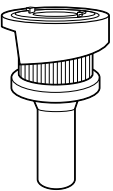

Clean cyclone with warm water and mild detergent.  
Let cyclone completely dry before replacing.  
To replace, align arrow on cyclone with the unlock ICON on the back of the tank. Press in and turn clockwise to lock.

6

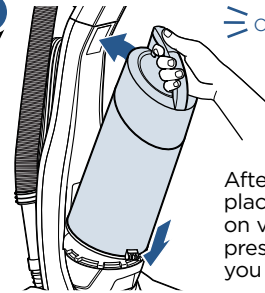

click

After emptied, place tank back on vacuum and press firmly until you hear "click".

**NOTE:** The dirt tank may be washed in warm water with a mild detergent. Make sure it is completely dry before replacing.

## Maintenance: Pre-Motor Filter



### WARNING

Do not operate vacuum with damp or wet filters or without all filters in place.

1

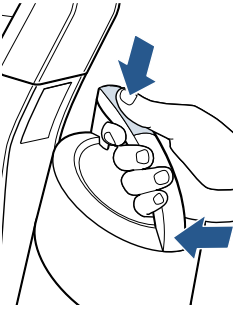

Press tank release button and remove dirt tank.

To access filter, Press the Filter button on front.

2



Remove foam filter from tray. Hand wash in warm water; mild detergent may be used if desired. Rinse well and then air dry thoroughly.

3



Make sure filter is completely dry before placing back into the tank lid. Close the lid to return the tank to the vacuum.

4

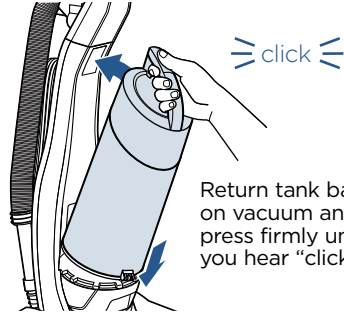

Return tank back on vacuum and press firmly until you hear "click".

## Maintenance: Post-Motor Filter

1

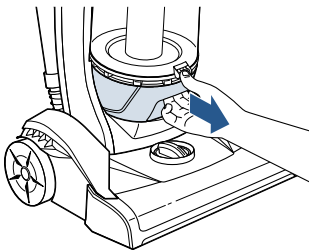

Firmly pull filter tray out.

2

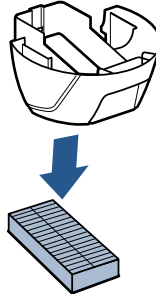

Push pleated filter down through filter tray.

**NOTE:** If dust and/or debris accumulates on the filter, gently tap the filter on the side of a garbage container.

**NOTE:** The pleated post-motor filter may NOT be washed with water or detergent. Replace the post-motor filter every 3 to 6 months.



# Maintenance: Brush & Belt

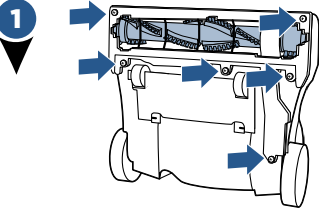

1 Unplug vacuum, turn over and unscrew six (6) Philips head screws to remove the bottom cover.

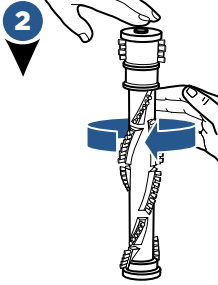

2 Clean debris from brush roll. Inspect by placing it on its end and spin. The brush roll should spin freely, multiple times by one flick. If it doesn't, replace brush roll.

Check belt for wear or cuts and replace if necessary.

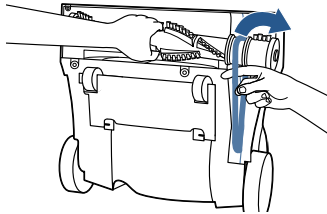
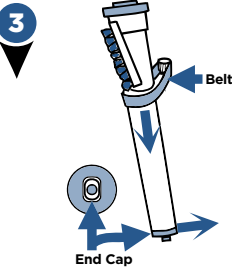

3 Thread belt and line up End Cap to reassemble roller. Replace bottom cover and 6 screws.

**NOTE:** If an object becomes lodged in foot and brush shuts off, turn vacuum off and unplug from electrical outlet. Remove obstruction and brush will automatically reset when vacuum is plugged and turned back on.

# Maintenance: TurboBrush® & TurboEraser® Tool

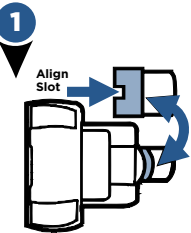

1 Twist gray collar counter clockwise, until slot appears, then separate faceplate.

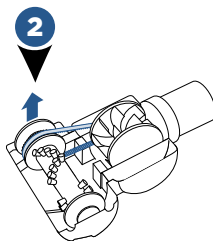

2 Remove brush roll, belt, and paddle wheel. Inspect for damages and replace if necessary.

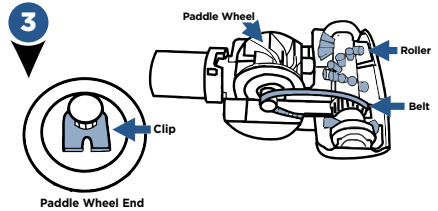

3 To reassemble, align two clips on each end of paddle wheel with belt on and pop back into place.

Place brush roll with belt back in.

Faceplate will not close properly if all parts are not aligned correctly.

# Troubleshooting

## **WARNING**

To reduce the risk of electric shock, turn power switch off and disconnect plug from electrical outlet before performing maintenance or troubleshooting checks.

<b>Problem</b>	<b>Possible causes</b>	<b>Remedies</b>
<b>Vacuum won't turn on</b>	Power cord not plugged in	Check electrical plug
	Blown fuse/tripped breaker	Check/replace fuse or reset breaker
<b>Vacuum won't pick up dirt</b>	Incorrect height adjustment	Adjust powerfoot to correct height setting
	Hose not attached to suction opening	Grasp the hose wand and firmly push into the hose wand base
	Crack or hole in hose	Check hose and replace if needed
	Broken or worn drive belt	Replace drive belt, see page 9
	Rotating floor brush jammed	Remove brush and clean debris from brush ends, see page 9
	Clog in vacuum	Check for debris build-up or clogs in the inner tank, hose and foot/lower hose; See online video for more help
	Dirt tank full	Empty dirt tank
	Dirt tank or upper tank not installed properly	Position correctly and lock in place, see page 7
	Filters are dirty	Check and clean or replace pre-motor and post-motor filters, see page 8
<b>Tool won't pick up</b>	Crack or hole in hose	Check hose and replace if needed
	Clog in vacuum	Check for debris build-up or clogs in the inner tank, hose and foot/lower hose; See online video for more help
	Dirt tank full	Empty dirt tank
	Dirt tank or upper tank not installed properly	Position correctly and lock in place, see page 7
	Filters are dirty	Check and clean or replace pre-motor and post-motor filters, see page 8
<b>Vacuum difficult to push</b>	Incorrect height adjustment	Adjust powerfoot to correct height setting, see page 6
<b>Visible dirt escaping from vacuum</b>	Dirt tank full	Empty dirt tank
	Filters missing or installed incorrectly	Check pre-motor and post-motor filters for correct installation, see page 8

# Warranty

This warranty gives you specific legal rights, and you may also have other rights which may vary from state to state. If you need additional instruction regarding this warranty or have questions regarding what it may cover, please contact BISSELL Consumer Care by E-mail, telephone, or regular mail as described below.

## Limited Two-Year Warranty

Subject to the \*EXCEPTIONS AND EXCLUSIONS identified below, upon receipt of the product BISSELL will repair or replace (with new or remanufactured components or products), at BISSELL's option, free of charge from the date of purchase by the original purchaser, for two years any defective or malfunctioning part.

See information below on "If your BISSELL product should require service".

This warranty applies to product used for personal, and not commercial or rental service. This warranty does not apply to fans or routine maintenance components such as filters, belts, or brushes. Damage or malfunction caused by negligence, abuse, neglect, unauthorized repair, or any other use not in accordance with the User's Guide is not covered.

BISSELL IS NOT LIABLE FOR INCIDENTAL OR CONSEQUENTIAL DAMAGES OF ANY NATURE ASSOCIATED WITH THE USE OF THIS PRODUCT. BISSELL'S LIABILITY WILL NOT EXCEED THE PURCHASE PRICE OF THE PRODUCT.

**Some states do not allow the exclusion or limitation of incidental or consequential damages, so the above limitation or exclusion may not apply to you.**

## \*EXCEPTIONS AND EXCLUSIONS FROM THE TERMS OF THE LIMITED WARRANTY

THIS WARRANTY IS EXCLUSIVE AND IN LIEU OF ANY OTHER WARRANTIES EITHER ORAL OR WRITTEN. ANY IMPLIED WARRANTIES WHICH MAY ARISE BY OPERATION OF LAW, INCLUDING THE IMPLIED WARRANTIES OF MERCHANTABILITY AND FITNESS FOR A PARTICULAR PURPOSE, ARE LIMITED TO THE TWO YEAR DURATION FROM THE DATE OF PURCHASE AS DESCRIBED ABOVE.

Some states do not allow limitations on how long an implied warranty lasts so the above limitation may not apply to you.

**NOTE:** Please keep your original sales receipt. It provides proof of date of purchase in the event of a warranty claim.

# Service

## If your BISSELL product should require service:

Contact BISSELL Consumer Care to locate a BISSELL Authorized Service Center in your area.

If you need information about repairs or replacement parts, or if you have questions about your warranty, contact BISSELL Consumer Care.

### Website:

[www.BISSELL.com](http://www.BISSELL.com)

### E-mail:

[www.BISSELL.com/email-us](mailto:www.BISSELL.com/email-us)

### Call:

BISSELL Consumer Care

1-800-237-7691

Monday - Friday 8am - 10pm ET

Saturday 9am - 8pm ET

Sunday 10am - 7pm ET

## Please do not return this product to the store.

Other maintenance or service not included in the manual should be performed by an authorized service representative.

For any questions or concerns, BISSELL is happy to be of service. Contact us directly at 1-800-237-7691.

# Register your product today!

Registering is quick, easy and offers you benefits over the lifetime of your product.

## You'll receive:

### **BISSELL Rewards Points**

Automatically earn points for discounts and free shipping on future purchases.

### **Faster Service**

Supplying your information now saves you time should you need to contact us with questions regarding your product.

### **Product Support Reminders and Alerts**

We'll contact you with any important product maintenance reminders and alerts.

### **Special Promotions**

Optional: Register your email to receive notice of offers, contests, cleaning tips and more!

Visit [www.BISSELL.com/registration!](http://www.BISSELL.com/registration!)

## Visit us online at: **BISSELL.com**

When contacting BISSELL, have model number of vacuum available.

Please record your

Model Number: \_\_\_\_\_

Please record your

Purchase Date: \_\_\_\_\_

**NOTE: Please keep your original sales receipt. It provides proof of purchase date in the event of a warranty claim. See Warranty on page 11 for details.**

*We can't wait to hear from you!*

We really do read your comments, tweets, and posts.

**Rate this product on BISSELL.com**

or any of our retailer sites and let us (and millions of your closest friends) know what you think!

## Parts & Supplies

For Parts and Supplies, go to **BISSELL.com** and enter your model number in the search field.

For cleaning tips and more visit [www.BISSELL.com](http://www.BISSELL.com) or find us at:



BISSELL



BISSELLClean



BISSELLClean



BISSELL



BISSELL



©2016 BISSELL Homecare, Inc.  
Grand Rapids, Michigan  
All rights reserved. Printed in China  
Part Number 161-0882 10/16 Rev.C  
Visit our website at: [www.BISSELL.com](http://www.BISSELL.com)