

## Portable Air Conditioner User Manual

Read and save these instructions before use

Customer Support:  
USA: 1-800-474-2147  
CANADA<sup>^</sup>: 1-888-209-0999

<sup>^</sup>Canada Customer Support service  
available for models sold in Canada only.

Email: [usinfo@jmatek.com](mailto:usinfo@jmatek.com)  
Web: [www.jmatek.com](http://www.jmatek.com)

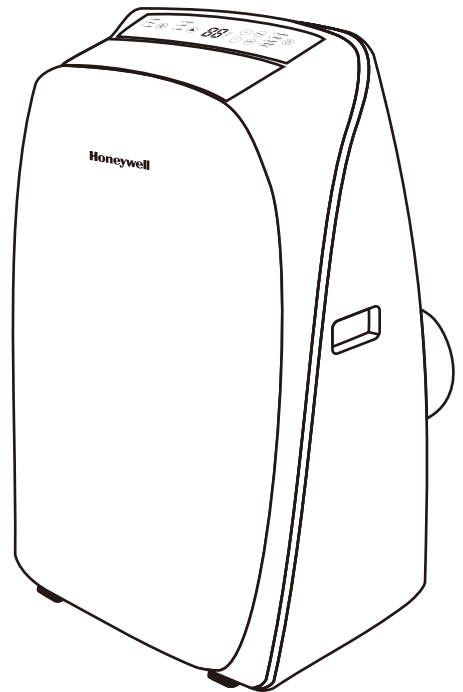

---

### Model :

**HL10 Series:** HL10CESWW, HL10CESWK, HL10CESWG, HL10CESWB

**HL12 Series:** HL12CESWW, HL12CESWK, HL12CESWG, HL12CESWB

**HL14 Series:** HL14CESWW, HL14CESWK, HL14CESWG, HL14CESWB

HL14CHESWW, HL14CHESWK, HL14CHESWG, HL14CHESWB

# THANK YOU

Congratulations on your purchase of this versatile Honeywell Portable Air Conditioner.

## USER TIPS

Honeywell Portable Air Conditioners are ideal for spot cooling. The compressor, condenser and evaporator are housed in a compact unit. The air is filtered, dehumidified and cooled while a flexible air outlet hose sends heat outside. The air conditioner includes a window venting kit.

No permanent installation is needed. The unit is easy to move from room to room and offers a truly flexible air conditioning solution.

Auto Evaporation System - The unit automatically evaporates the condensate through the air outlet hose. There is no need to empty the drainage tank except in very humid conditions.

Read and follow the instructions carefully.

## USER TIPS

To ensure optimal efficiency of the product, keep doors and windows closed when it is used as an air conditioner or dehumidifier. If the product is being used with the fan function only, an open window could improve air circulation.



Cooling and Dehumidifying Operation



Fan Operation

### Important:

Before installing the unit, place it UPRIGHT for 1 hour before use to allow the refrigerant to stabilize. Air outlet automatically opens when the unit is turned on, and automatically closes when the unit is turned off. Manually adjust the air vent located at the top of the unit to adjust the direction of air flow.

- Follow installation instructions to set up the unit.
- Plug the unit into a properly grounded circuit. DO NOT plug into an extension cord.

# SAFETY

## READ AND SAVE THESE INSTRUCTIONS

Improper handling can cause serious damage to people and to the appliance.

### WARNING:

- DO NOT operate the unit with a damaged plug or loose wall outlet. If the power cord is damaged, it must be replaced by the manufacturer or an authorized service agent.
- DO NOT cover the air intake and exhaust when in use.
- This appliance is not intended for use by children. Children should be supervised and should not play on or around the appliance.
- DO NOT place objects on or sit on the unit.
- Always turn off and unplug the unit when cleaning or servicing.
- If service is needed contact an authorized service agent.
- Unplug the unit when stored or not in use.
- DO NOT run the power cord under carpeting and rugs.
- Use caution to prevent tripping on cord.
- DO NOT use in areas where gasoline, paint or other flammable goods are stored.
- Basic safety precautions should always be followed when using electrical appliances.
- This household appliance has been manufactured for use in domestic environments and should not be used for other purposes.
- Only use the installation kit provided to install this unit. DO NOT attempt to extend the exhaust hose or install this unit using other methods other than that provided in this manual. Improper installation could void any existing warranties. Contact Customer Support for assistance if required.
- DO NOT use an extension cord with this unit.

## PARTS DESCRIPTION

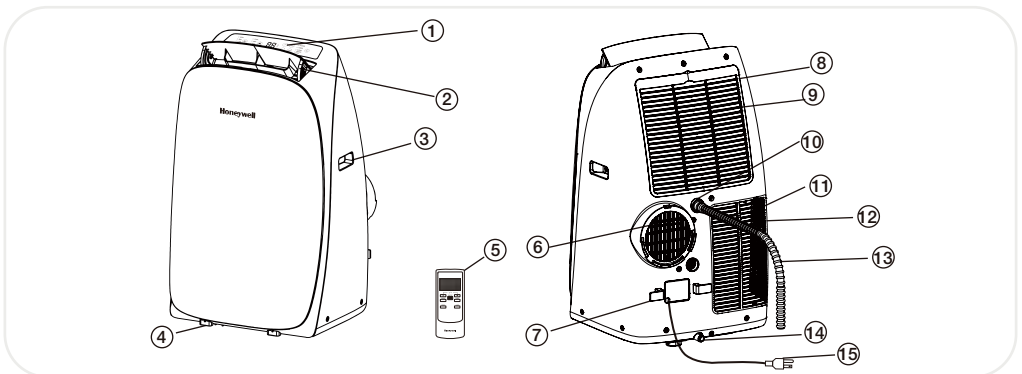

1) Control Panel

2) Air Outlet

3) Handle

4) Casters

5) Remote Control

6) Exhaust Hose Connector

7) Cord Winder

8) Upper Grill

9) Upper Air Filter

10) Upper Rubber Drain Plug  
(Dehumidifying Mode)

11) Lower Air Filter

12) Lower Grill

13) Drain Tube  
(For Continuous Drain)

14) Lower Rubber Drain Plug  
(Air Conditioning Mode)

15) Power Supply Cord

# INSTALLATION

It is important that the installation instructions below are followed for successful installation of this portable air conditioner. Please call Customer Support if you have any difficulties or queries regarding these installation procedures.

## Installation Kit:

1. Window Bracket Kit..... 1 Set
2. Window Bracket Panel Adapter..... 2 Half Pieces
3. Plastic Pin..... 1 Piece
4. Hose Connector..... 1 Piece
5. Plastic Hose..... 1 Piece
6. Drain Tube (refer to Continuous Draining for Dehumidifier Mode)..... 1 Piece

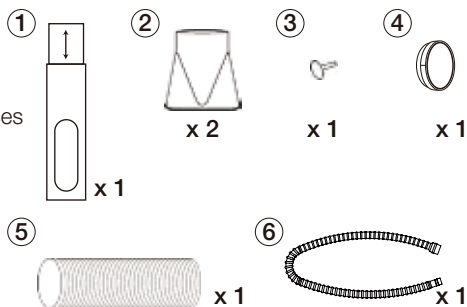

## Installation Steps:

1. Locate and snap the 2 half pieces of the Window Bracket Panel Adapter securely together. Install onto the plastic hose by rotating anti-clockwise over the plastic hose. Install and rotate (anti-clockwise) the hose connector over the opposite end of the plastic hose. Ensure secure fit on both ends.

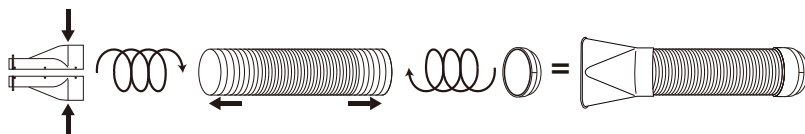

2. Adjust the window bracket as per width or height of your window and insert the plastic pin to fix at the desired position. There is a hole where the Plastic Hose will be inserted later. Make sure this hole is not blocked.

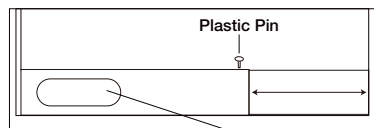

26.6", 33.1" to 49.6"  
(67.5cm, 84cm to 126cm)

Hole for Window Bracket  
Panel Adapter & Plastic Hose

### Note:

After setting the window bracket to the size of your window, please remove it from the window and follow the instructions below.

4. Connect the window bracket to the window bracket panel adapter. Ensure that all connections are tight and installed properly.

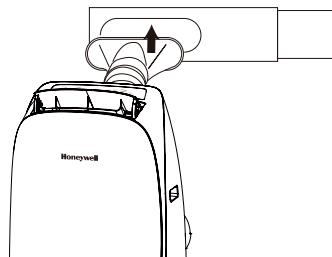

3. Connect the plastic hose to the hose connector on back of the unit. Slide-in the hose connector downwards until it is locked in place.

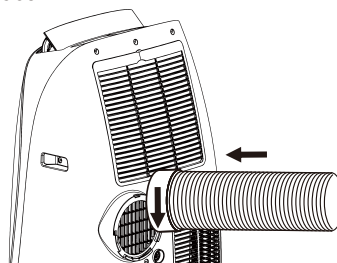

Plastic Hose:  
Dia. 5.9" (15cm)  
Length: 14.2" to 47.2" (36cm to 120cm)

5. Connect the window bracket to the window.

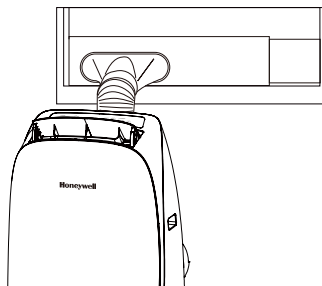

6. The Portable Air Conditioner is now ready to use.

# INSTALLATION (CONTINUED)

## IMPORTANT:

- Do not replace or lengthen the exhaust hose as this could cause the unit to malfunction.

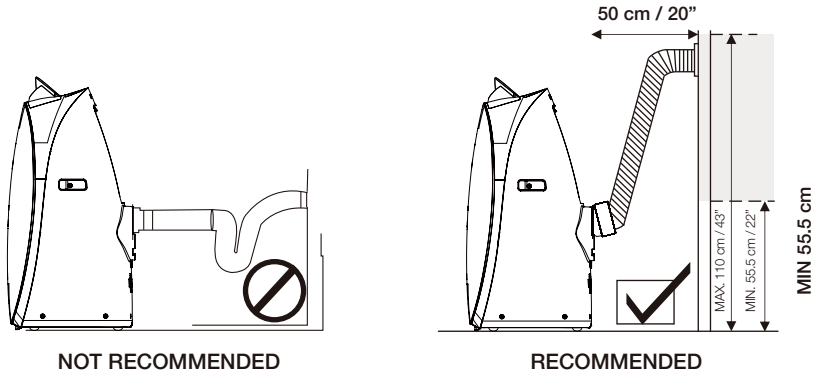

**WARNING:** Any warranties included with this product will be voided if an extra extension hose is added to the originally provided installation kit or if the installation is performed differently than the manufacturer's instructions, without proper consultation. Please contact Customer Support for help with installation if needed.

- The supplied exhaust hose has a diameter of 5.9 inches (15 cm) and can be extended from 14.2 inches to 47.2 inches (36 cm to 120 cm).
- Do not bend (to the extent shown below) the exhaust hose. A bent hose will block exhaust air and cause the unit to malfunction or shut-off.
- Make sure the back of the unit is at least 50 cm / 20 inches away from the wall. Do not place the unit in front of curtains or drapes as this could obstruct the airflow.

# USE & OPERATION

## CONTROL PANEL

Model without Heat Mode



Model with Heat Mode

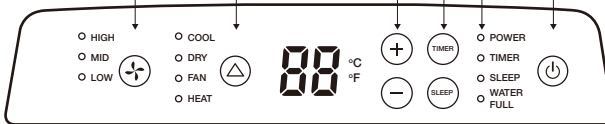

- Power Control
- Indicator Lights
- Timer Control / Sleep Control
- Timer / Temperature Set Controls
- Mode Control
- Fan Speed Control

## FUNCTION BUTTONS

### POWER CONTROL

The Power Control turns the unit on and off. When the unit is plugged into an appropriate electrical outlet, the POWER indicator light will illuminate red indicating the unit is in a Standby Mode, ready to be switched on at anytime. The air vent will automatically open when the unit is turned ON and automatically close when unit is turned OFF.

## FUNCTION BUTTONS (CONTINUED)

### MODE CONTROL

Settings: COOL, DRY, FAN and HEAT\*. The corresponding indicator light will illuminate to indicate the current mode setting.

- Air Conditioning Mode (COOL)

Adjust fan speed and air temperature to suit your desired comfort level. Temperature setting range is 16°C - 32°C (61°F - 89°F).

- Dehumidifying Mode (DRY)

Fan speed is preset to LOW.

**Note:** If the unit will be used mainly as a dehumidifier, do not connect the exhaust hose. Continuous drainage is then necessary (refer to Continuous Draining for Dehumidifier Mode).

- Fan Mode (FAN)

For air circulation without air conditioner cooling.

- Heating Mode (HEAT)\*

In this mode, the desired temperature can be set between 16°C - 32°C (61°F - 89°F). When in heating mode condensation must be drained from the lower drain plug.

**Note:** The air exchange hose must vent outside the room when using heating mode.

- Sleep Mode (SLEEP)

When the Sleep Mode is activated in Air Conditioning mode, the set temperature will increase by 1°F or 1°C after the first hour of cooling and will increase a further 1°F or 1°C after the second hour of cooling. The unit will maintain this temperature for 5 hours. The set temperature will then reduce by 1°F or 1°C on the seventh hour and reduce a further 1°F or 1°C on the tenth hour. Sleep mode will then deactivate automatically.

In Heating Mode\*, the set temperature will reduce by 2°F or 2°C after the first hour of heating\* and will reduce a further 2°F or 2°C after the second hour of heating\*. The unit maintains heating\* at this temperature for 5 hours. Then, the set temperature will increase 2°F or 2°C at the seventh hour and will increase a further 2°F or 2°C on the tenth hour. Sleep mode will then deactivate automatically.

**Note:** The Sleep Mode can be deactivated during cooling or heating\* mode by pressing any button at any time.

\*Applicable for models with Heating feature only.

## FUNCTION BUTTONS (CONTINUED)

### FAN SPEED CONTROL

3 settings: High, Medium and Low.

### TIMER CONTROL

The Timer is adjustable between 1 - 24 hours.

#### AUTO TURN OFF:

While unit is running, press the TIMER button and the display will flash. While the display is flashing, press the + or - button to select the number of hours you want the unit to turn OFF automatically.

#### AUTO TURN ON:

When unit is in a standby mode (plugged in with power light on), press the TIMER button and the display will flash. While the display is flashing, press the + or - button to select the number of hours until you want the unit to turn ON automatically.

### TEMPERATURE CONTROL

- Used for adjusting the timer and thermostat.
- The default display is room temperature.
- In cooling mode, when + or - button is pressed, the set temperature is displayed and may be adjusted. After 5 seconds the display will revert back to room temperature.

**Note:** By pressing both + / - buttons at the same time, the display will toggle between Celsius and Fahrenheit.

### WATER FULL LIGHT

Condensation may accumulate in the unit. If the bottom internal tank is 50% full, the WATER FULL light will illuminate. If the bottom internal tank is 100% full, an alarm will beep for 30 seconds. The unit will not operate until the water has been drained from the bottom drain plug (refer to Water Condensation Drainage).

**After switching the air conditioner off, the compressor will not start immediately. You must wait about 3 minutes before it switches back on again.**

## REMOTE CONTROL

The functions work the same as the portable air conditioner's Control Panel. All key functions can be accessed from the remote control.

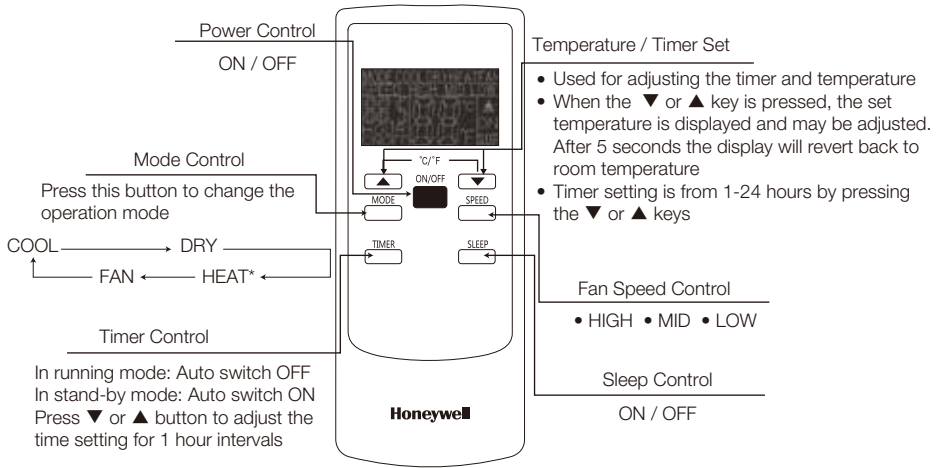

\*Applicable for models with Heating feature only.

### Note:

- **Battery Installation:** Remove the cover on the back of the remote control and insert two AAA batteries with + and - pointing in the proper direction according to the polarity markings.



### Caution:

- Use only two AAA or IEC R03 1.5V batteries.
- Remove the batteries if the remote control is not in use for a month or longer.
- All batteries should be replaced at the same time, do not mix with old batteries.
- Properly dispose of used batteries.

This device complies with part 15 of the FCC Rules. Operation is subject to following two conditions: (1) this device may not cause harmful interference, and (2) this device must accept any interference received, including interference that may cause undesired operation.

This equipment has been tested and found to comply with the limits for a Class B digital device, pursuant to part 15 of the FCC Rules. These limits are designed to provide reasonable protection against harmful interference in a residential installation. This equipment generates, uses and can radiate radio frequency energy and, if not installed and used in accordance with the instructions, may cause harmful interference to radio communications. However, there is no guarantee that interference will not occur in a particular installation. If this equipment does cause harmful interference to radio or television reception, which can be determined by turning the equipment off and on, the user is encouraged to try to correct the interference by one or more of the following measures:

- Reorient or relocate the receiving antenna.
- Increase the separation between the equipment and the receiver.
- Connect the equipment into an outlet on a circuit different from that to which the receiver is connected.
- Consult the dealer or an experienced radio/ TV technician for help.

Caution: Any changes or modifications not expressly approved by the party responsible for compliance could void the user's authority to operate the equipment.



## Appliance Maintenance:

1. Turn off the appliance before disconnecting the power supply.
2. Only clean the appliance with a soft dry cloth.

## Air Filter Maintenance:

The air filter is to be cleaned every two weeks to maintain a cleaner environment and air cooling efficiency. Please follow the below instructions for cleaning the air filters:

1. Switch off and unplug the air conditioner from the electrical outlet.
2. Remove the Upper Filter/Grill and unscrew the Lower Filter/Grill and carefully remove.
3. Gently wash using water and/or diluted liquid dishwashing detergent. Rinse thoroughly and gently shake excess water from the filters.  
Make sure the filters are dry before reinstalling.  
Note: You may use a vacuum cleaner to remove dust.
4. Replace the Upper Grill onto the unit, and reinstall the Lower Grill with the screws.

**WARNING:** DO NOT power or operate the Air Conditioner when cleaning or when any or both of the Rear Grills are removed from the unit, or if there is a loose-fitting Rear Grill(s). DO NOT attempt to handle or touch any of the parts or wiring inside the air conditioner after the Rear Grill(s) are removed from the unit. Doing so can cause serious injury or electrical shock.

## End of Season Storage & Maintenance:

If the appliance will not be used for a long time:

1. Be sure to drain the left-over water condensation. Remove the lower drain plug and use a shallow pan to collect the water (make sure to replace the drain plug when finished).
2. To dry excess moisture, run the unit in Fan only mode for 30 minutes before storing.
3. Turn off and unplug the air conditioner from the power supply.
4. Remove the air filter and clean with water. Dry the air filter and then reinstall.
5. Disconnect the Window Installation Kit:
  - Remove the Plastic Hose from the unit.
  - Remove the Window Bracket, Window Bracket Panel Adapter and Hose Connector.
  - It is recommended to store the Window Kit parts in a bag together with the Remote Control and placing them together with the air conditioner unit.
  - If needed, you can clean the Window Kit with a damp cloth and water before storing. Make sure all parts of the Window Kit are dry before storage.
6. Cover the air conditioner with a cloth/ plastic bag before storage, to protect from dust and scratches.
7. It is recommended to coil the power cord before storing to ensure the cord is protected from bents and creases.
8. Store the air conditioner in a cool, dry place, away from direct sunlight.

## WATER CONDENSATION DRAINAGE

When there is excess water condensation inside the unit, the air conditioner stops running and shows a warning light (the WATER FULL indicator illuminates with a red light). This indicates that the water condensation needs to be drained using the following procedures:

### Manual Draining for Cooling, Heating & Dehumidifier Mode

Water may need to be drained in high humidity areas.

1. Unplug the unit from power source.
2. Place a shallow pan under the lower rubber drain plug.  
See diagram.
3. Remove the rubber drain plug.
4. Water will drain out and collect in the shallow pan.
5. After the water is drained, replace the rubber drain plug.
6. You can now turn on the unit.

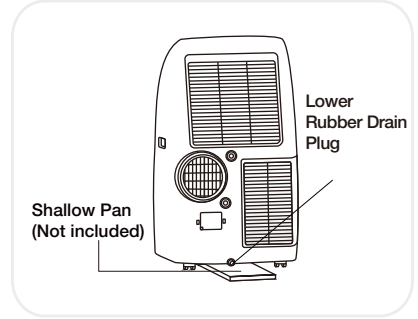

### Continuous Draining for Dehumidifier Mode

While using the unit in dehumidifier mode, continuous drainage is recommended.

1. Unplug the unit from the power source.
2. Remove the upper/lower rubber drain plug. Some residual water may spill so please have a pan to collect the water.
3. Connect the drain tube (included) to the upper or lower drain (whichever is more convenient for your space). See diagram.
4. The water can be continuously drained through the drain tube into a floor drain or bucket.
5. Replace the drain plug.
6. You can now turn on the unit.

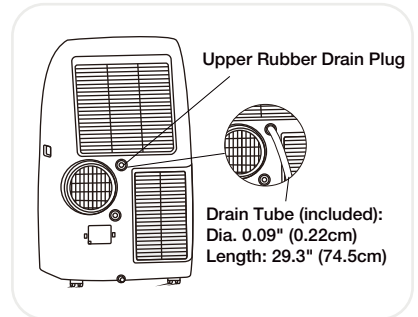

# TROUBLESHOOTING GUIDE

The following troubleshooting guide addresses the most common problems. If problems persist, call customer service. Unplug and disconnect the appliance from the power source before attempting to troubleshoot.

PROBLEM	POSSIBLE CAUSE	SOLUTION
The air conditioning unit does not start	<ul style="list-style-type: none"> <li>• No electricity.</li> <li>• Batteries in the remote control need to be replaced.</li> <li>• The power cord is not properly plugged in.</li> <li>• The safety LCDI plug has tripped (USA / Canada / Mexico only).</li> </ul>	<ul style="list-style-type: none"> <li>• Check for power.</li> <li>• Change remote control batteries.</li> <li>• Remove and reconnect the power cord.</li> <li>• Reset the safety LCDI plug, if problem persists contact our customer support (USA / Canada / Mexico only).</li> </ul>
Runs only a short while	<ul style="list-style-type: none"> <li>• The thermostat temperature setting is too close to the room temperature.</li> <li>• Air outlet is blocked.</li> <li>• There are tight bends in the air exhaust hose.</li> </ul>	<ul style="list-style-type: none"> <li>• Lower the set temperature.</li> <li>• Make sure the exhaust hose is properly connected.</li> <li>• Connect exhaust hose as per instructions on page 4.</li> </ul>
Runs but not cooling	<ul style="list-style-type: none"> <li>• A door or window is open.</li> <li>• The air filter is dirty.</li> <li>• The exhaust hose is detached.</li> <li>• Temperature setting is too high.</li> <li>• Air outlet or intake is blocked.</li> <li>• Room exceeds recommended size.</li> <li>• Large size or number of windows are decreasing cooling effectiveness.</li> </ul>	<ul style="list-style-type: none"> <li>• Make sure the window or door is closed.</li> <li>• Clean the air filter.</li> <li>• Reinstall exhaust hose properly (refer to Installation section).</li> <li>• Reduce temperature setting.</li> <li>• Remove blockage.</li> <li>• Move unit to smaller room.</li> <li>• Cover windows with curtains or blinds.</li> </ul>
Will not run and WATER FULL indicator is on	<ul style="list-style-type: none"> <li>• Excess water condensation inside the tank.</li> </ul>	<ul style="list-style-type: none"> <li>• Drain the water (refer to Water Condensation Drainage).</li> </ul>
Heater* is not switching ON (This applies to Portable Air Conditioner models with built-in Heating* function only).	<ul style="list-style-type: none"> <li>• Heating* function not activated yet. Temperature setting is too low.</li> </ul>	<ul style="list-style-type: none"> <li>• Check that the Heating* function has been activated. Increase temperature setting.</li> </ul>

\*Applicable for models with Heating feature only.

Customer Support:  
USA: 1-800-474-2147  
CANADA<sup>^</sup>: 1-888-209-0999

<sup>^</sup>Canada Customer Support service  
available for models sold in Canada only.

**JMATEK North America LLC**  
Mahwah, New Jersey 07495 USA  
Phone: 1-800-474-2147  
Email: [usinfo@jmatek.com](mailto:usinfo@jmatek.com)  
Web: [www.jmatek.com](http://www.jmatek.com)

Made in China  
© 2015 JMATEK Limited. All rights reserved.  
The Honeywell Trademark is used under license  
from Honeywell International Inc.  
Honeywell International Inc. makes no  
representations or warranties with respect to this product.  
This product is manufactured by Airtek Int'l Corp. Ltd.  
(subsidiary of JMATEK Ltd.).

**Honeywell**